

APPENDIX 7.0

Hydrology Study/Water Quality Management Plan



PRELIMINARY
Hydrology Study
August 30, 2023

APN: 0463-491-09

Cordova Business Center

RBCEA PROJECT NO: 220060

**Town of Apple Valley,
San Bernardino County,
California**



**PROFESSIONAL ENGINEER'S
AFFIRMATIVE STATEMENT**

I have examined and am familiar with the information in this document and all appendices, and based on my inquiries of individuals immediately responsible for obtaining the information in this document, I believe that the information is true, accurate, and complete

Prepared by
RED BRICK CONSULTING

Engineers & Architects, LLC

www.rbcea.com

Main Office

2892 S. Kollman Lane
Saratoga Springs, Utah 84045
T: 801.331.8900

Apple Valley Office

19153 Town Center Dr. | Suite 101-A
Apple Valley, CA 92308
T: 661.816.5179

Table of Contents

I.	Introduction	
A.	Location of Property	1
B.	Project Description	1
C.	Purpose and Scope	1
D.	Methodology	1
E.	Floodplain Information	2
II.	Hydrology	2
A.	Pre-Developed Drainage Description	2
B.	Pre Developed Hydrology	3
C.	Post-Developed Drainage Description	3
D.	Post Developed Hydrology	4
E.	Retention Basin Requirements	4
	ΔV Mitigation	4
	WQMP-Dcv	4
	Basin Sizing	4
	On-Site Flow Clarification	5
	Infiltration System	5
V.	Conclusions	6

Appendix A – Exhibits

Exhibit A - Location Map
 Exhibit B - Land Use Map
 Exhibit C - Soils Report
 Exhibit D - San Bernardino County CN Values Chart
 Exhibit E - NOAA 14 Precipitation Depths
 Exhibit F - Predeveloped Hydrology Map
 Exhibit G - Developed Hydrology Map

Appendix B – Calculations

100 Year 1 Hour Pre-Developed Rational Method DA1-DA2
 100-Year 24-hour Pre-Developed Unit Hydrograph Method DA1-DA3

 100 Year 1 Hour Post-Developed Rational Method DA1-DA3
 100-Year 24-hour Post-Developed Unit Hydrograph Method DA1-DA3

Appendix C – PWQMP

Town of Apple Valley Water Quality Management Plan & Checklist

I. INTRODUCTION

A. LOCATION OF PROPERTY

The proposed project is located in the Town of Apple Valley, San Bernadino County, California at the southwest corner of Central Road and unimproved Cordova Road. The 29.79-acre project site consists of Assessor's Parcel Number (APN) 0463-491-09 (See adjacent Figure 1.) For more detailed information please refer to Exhibit A for Location Map and Exhibit B for Land Use ed

The project is bounded on the north by the unimproved Cordova Road, the south by vacant land, west also by vacant land, and east by Central Road. This project surrounds approximately 20 acres of vacant land in the middle of the site.

B. PROJECT DESCRIPTION

The proposed site will be developed as an industrial project with a 493,000 square foot industrial building, truck docks, and vehicle parking.

C. PURPOSE AND SCOPE

The project site is located within the Apple Valley Dry Lake Tributary Watershed and outside and independent of the Mojave River Watershed. Thus, the project is subject to the Mojave River Water Quality Management Plan. A Preliminary Water Quality Plan Checklist and Infiltration Requirement is required and provided as Appendix C herein. The purpose of this study is to identify the tributary drainage areas that influence the project site and determine the pre and post developed 100-year storm water volume associated with these areas, such that the added developed storm water volume will be mitigated to below the predeveloped storm volume currently associated with the dry lakebed. All flows will exit the site into their natural and historic drainage conveyances. In addition, the project will identify the 100-year 24-hour flood water elevation and recommend pad elevations to be elevated one foot above for flood protection.

D. METHODOLOGY

This study is based on the San Bernardino County Hydrology Manual, and as directed by the Town of Apple Valley, this study will analyze the 100-year 24-hour storm event to mitigate the differential (ΔV) between the post-developed increase storm water runoff volumes and the pre-developed storm water volume in order to ensure no increase in storm water volume is received into the Apple Valley Dry Lake. CivilDesign Unit Hydrograph Software will be used to model the storm flow and runoff.



The following criteria were used to calculate the flows:

- | | |
|--|---|
| 1. Current land use: | Vacant Land |
| 2. On-Site Proportion Impervious: | Predeveloped: 0%;
Post-Developed: 85 % |
| 3. Intended Use: | Industrial Building and Truck/Employee Parking |
| 4. Soil Type: | Hydrologic Soil Groups A and C (See Exhibit C) |
| 5. NOAA 14 Precipitation Frequency: | 100 year 1 hour = 1.08 inches
100 year 6 hour = 2.01
100-year 24-hour = 3.44 inches (See Exhibit D) |
| 6. San Bernadino County Hydrology Manual | Rational Method and Unit Hydrographs
(See Appendix B) |

E. FLOODPLAIN INFORMATION

The project site is located inside of the Federal Emergency Management Agency (FEMA) Flood Insurance Rate Map Panel 06071C5835H effective August 28,2008. This panel indicates that the site is located within Zone D, defined by FEMA as “Areas with possible but undetermined flood hazards. No flood analysis has been conducted.”

II. HYDROLOGY

A. PRE-DEVELOPED DRAINAGE DESCRIPTION

The predeveloped project watershed consists of two areas, the 29.79 acres of the project site and the remaining off-site 20.2 acres (separated into 8 parcels) that is surrounded by the project site on three sides, with Central Road on the east. The total of 49.99 acres will be used to determine the predeveloped volume of the area. Due to the unusual configuration of the project, area averaging will be used to determine the volume specific to our site.

The area generally slopes from the northeast to the southwest at an average of 1.36% from corner to corner, is undeveloped, barren land with poor cover of annual grasses and blue sage. The soil consists of 55% group A and 45% group C soil. The CN values are taken from the San Bernardino Hydrology Manual, Sec C, natural cover classification as Open Brush, poor quality of cover, with corresponding CN values of 62 and 84 respectively. (See Exhibit C).

A Blue Line stream indicated on the USGS map lies north of the site and travels southwest around the west side of the site and crosses Cordova Road 140 feet to the west of the site.

Another USGS Blue Line stream coming from the northeast crosses Central Road on to the “not a part” 20.2 acre properties surround by the site and continues traveling southwest where it crosses the on-site tip of southeasterly narrow strip of the parcel.

The area where this Blue Stream crosses the tip of the narrow strip of the project will remain undeveloped and is labeled DA3. (See Exhibit E). DA3 covers an on and off-site tributary area of 5.64 acres with 1.87 of those acres being on-site. The 5.64 acres was subtracted from the total acres. $(49.99 - 5.64 = 44.35)$ and 1.87 acres was deducted from the site. $(29.79 - 1.87 = 27.92)$

B. PRE-DEVELOPED HYDROLOGY

The remaining area was divided into 2 Drainage Areas (DAs). DA1 and DA2 were analyzed using CivilDesign Rational Method for a 100 year 1 hour storm to obtain the Time of Concentration, for both AMCIII and AMC II CN values and pervious ratio for each area. (See Appendix B) This information was then used to run a corresponding 100 year 24 hour storm Unit Hydrograph for each DA area as tabulated below.

Drainage Area #	Volume AMCIII AF	Volume AMCII AF
DA1 =	5.01	4.98
DA2 =	6.98	3.59
DA3 =	NA	NA
Total of	11.99	8.57
		29%

Using the AMCII volumes across the entire on and off-site watershed shows a 29% reduction in storm volume which exceeds the 90% reductions required in the hydrology manual.

Thus, area averaging to determine the volume that should be assigned to the project site yields. $(27.92/44.35 = 63\%)$ 63% of 8.57 acre feet = 5.40 acre feet. The remaining 37% (3.17 af) were assigned to off-site flows that will need to pass through the site and continue on to the Dry Lakebed.

C. POST-DEVELOPED DRAINAGE DESCRIPTION

The developed site was divided into 3 drainage areas. Total area covered by the 3 DAs equals 26.22 acres. DA1 covers the north parking along Cordova Road, the associated landscaping, and the north half of the roof. DA2 includes the parking area immediately west of the building, the south half of the roof, landscaping along Central Road, and the truck wells on the south side. DA3 covers the remaining dog leg shaped truck parking on the west and south property lines. The parking lots and drive isles generally slope at 0.5% to the west and south.

D. POST-DEVELOPED HYDROLOGY

Again, 100-year 1 hour Rational Method studies were performed to obtain the Time of Concentration, CN values and percent pervious. When choosing “Commercial” as the land use type, the program automatically assigns an AMC II CN number of 98 for hardscapes and a value based on soil type and vegetative cover per Exhibit D Figure C-3 a CN value of 56 was used. The program also automatically assigns a pervious fraction (Ap) of 0.100). Since there will be less landscaping, an Ap of 0.05 was used.

Unit Hydrographs were run using the information obtained from the rational Method, but with the changes to the CN Value and Ap fraction. The volumes for each area were as follows:

Drainage Area #	Volume AF
DA-1 =	2.5684
DA-2 =	2.992
DA-3 =	1.4254
Total of	6.9858

The combined volume obtained from the 3 Unit Hydrographs for the 26.22 acres is 6.9858-acre feet

E. RETENTION BASIN REQUIREMENTS

ΔV Mitigation (Dry Lakebed Reduction)

Although, the San Bernardino County Detention Basin Design Criteria Memorandum File: 1 (FC)-53, requires the mitigation of the ΔQ (the difference between the post-developed AMC III 100-year 24-hour peak flow rate reduced by detention to 90% of the pre-developed AMC II 25-year storm’s peak flow rate), this procedure assumes that storm waters will be conveyed to a major stream and eventually to the ocean so increases in the volume of water are not a consideration. This location in the Town of Apple Valley is uniquely susceptible to changes in volume considering that it directly affects the flood elevation of the Apple Valley Dry Lakebed. Thus, pursuant to Town’s EIR (SCH#2008091077) Apple Valley General Plan and Annexation 2008-001 & 2008-002 Local Drainage Management, “The Town retains direct responsibility for local drainage management” and at the direction of the Town of Apple Valley , based on the 100-year 24-hour storm event, the proposed project is required to mitigate the post- developed increase storm water runoff volumes to below the pre-developed storm water volume (ΔV) in order to ensure no increase in storm water volume is received into the Apple Valley Dry Lake. The captured or retained stormwater is required to infiltrate into the ground. Off-site flows will be conveyed through or around the project and released within their associated natural, historic watershed conveyances to the Apple Valley Dry Lake.

From our analysis, it was determined that predeveloped volume is 5.40 acre feet and the post developed volume of 6.99 yeilds a ΔV of $(6.99 - 5.40 = 1.59)$ 1.59 acre feet to be retained and infiltrated on site. Retention volumes should include a factor of safety and retain more than this ΔV which is required in the WQMP Dcv.

Water Quality Management Plan – Dcv

In order to comply with the County’s requirements to prepare a Water Quality Management Plan (WQMP) within the Dry Lakebed watershed, the Town of Apple Valley has developed a preliminary WQMP form and checklist to obtain the required “Design Capture Volume”. The PWQMP is presented in Appendix C that has determined that the Dcv requirement is 1.28 – acre feet which is less than the 1.59 acre foot requirement above. The 1.59 is a factor Safety of 1.24.

Basin Sizing

The greater 1.59 acre foot volume will be achieved by retaining storm water in the truck wells for DA2 that consists of 2 basins. The first one would use the landscape area on the west side of the truck wells as a dam. The deepest part of the basin when filled with water would be approximately 3 ft deep and would contain a volume of 0.52 acre feet.

The second basin would start at the east side of the landscape area placed at the center of the building and would contain a volume of 0.48-acre feet. The 2 basins would combine to hold 1.0-acre feet of water ($0.52 + 0.48 = 1.0$)

The remaining 0.59-AF of storage volume shall be provided in the southerly two (2) truck well basins in DA3. The first would start at the west property line where the depth would be approximately 3 ft deep at the deepest part. Due to the grading design this basin would contain approximately 0.29 acre feet of storm water. The second basin requires a retaining division wall structure at the upstream end of the first basin in order to retain the additional 0.29 acre feet of water, thus meeting the need to retain 0.59 acre feet of water.

On-Site Storm Flow Clarifiers – CDS System Sizing

Mandatory compliance with the Proposed Project’s SWPPP and WQMP, in addition to compliance with NPDES Permit requirements will provide BMP’s to ensure that all potential pollutants of concern are minimized or otherwise appropriately treated prior to being discharged from the Project Site.

In order to protect off-site flows from on-site contaminated flows, four Contech CDS System clarifiers CDS2020-5 will be installed to treat on-site 1st flush flows prior to exiting the site into the Off-site drainage conveyance channels and the Maxwell Drywell infiltration systems. The CDS System separates and traps trash, debris, sediment, and hydrocarbons from storm water runoff.

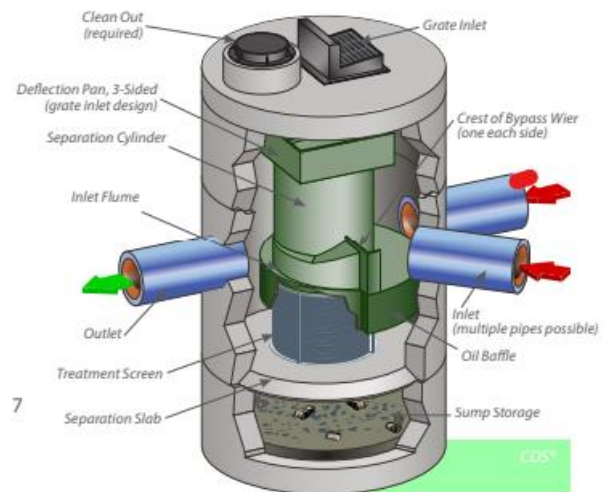

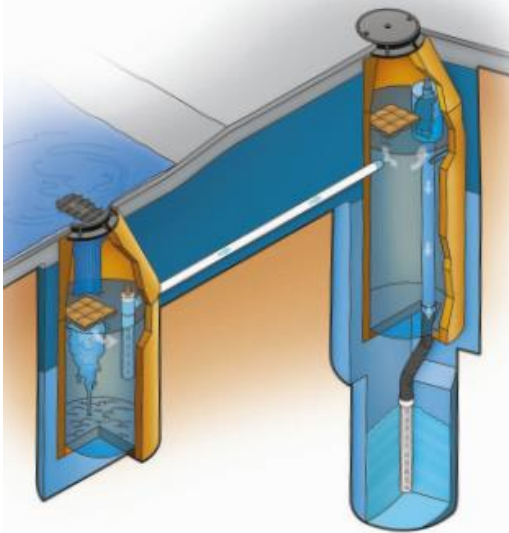

Infiltration System

To infiltrate the 1.59 acre feet of storm water, a Maxwell Plus infiltration system shall be designed for each drainage area's volume requirements. Infiltration testing performed by Landmark Consultants, Inc indicates that the infiltration rates are between 2.11 and 2.48 inches per hour. Using a 60-ft maximum depth to drain the retained 1.59-acre foot of storm volume within 48-hours will require nine (9) Maxwell-infiltration chambers.

III. CONCLUSIONS

The proposed project will follow local requirements to store the developed ΔV and Dcv on-site and infiltrate these flows into the ground and convey the excess storm water flows back to their historic conveyance condition. The requirement for mitigation of the 100-year 24 hour developed storm volumes by retaining 1.59 acre feet of storm flow.

Four Contech CDS System clarifiers CDS2020-5 shall be installed to treat the storm flows prior to releasing them into a series of nine (9) Maxwell Drywell infiltration systems that will drain the basins within the 48-hours required by the WQMP.

The Project is located outside of the requirements of the County of San Bernardino and the Phase II Small MS4 General Permit for the Mojave River Watershed as it drains to the Apple Valley Dry Lakebed.

As proposed the project will have less than significant Impact with mitigation on hydrology and water quality considering it will reduce the flows to below pre-developed levels, treat contaminants and remove debris prior to releasing the retained flows into the aquifer, and will not increase up or down stream flood elevations. Since the project is located at the top of a ridge line off-site flows are directed around the project by means of existing natural channels and proposed off-site street improvements. Thus, the finish floor Pad elevation needs only to be elevated 1-foot above the proposed flowline at its highest elevation.

Once all proposed measures are constructed the project will meet the guidelines of the San Bernardino County Hydrology Manual for flood protection.

APPENDIX A

Exhibits:

- Location Map – A
- Land Use Map - B
- USDA Soil Report – C
- SBCHM Curve Numbers for Pervious Areas – D
- NOAA 14 Precipitation Depths – E
- Pre-Developed Hydrology Map - F
- Post-Developed Hydrology Map - G

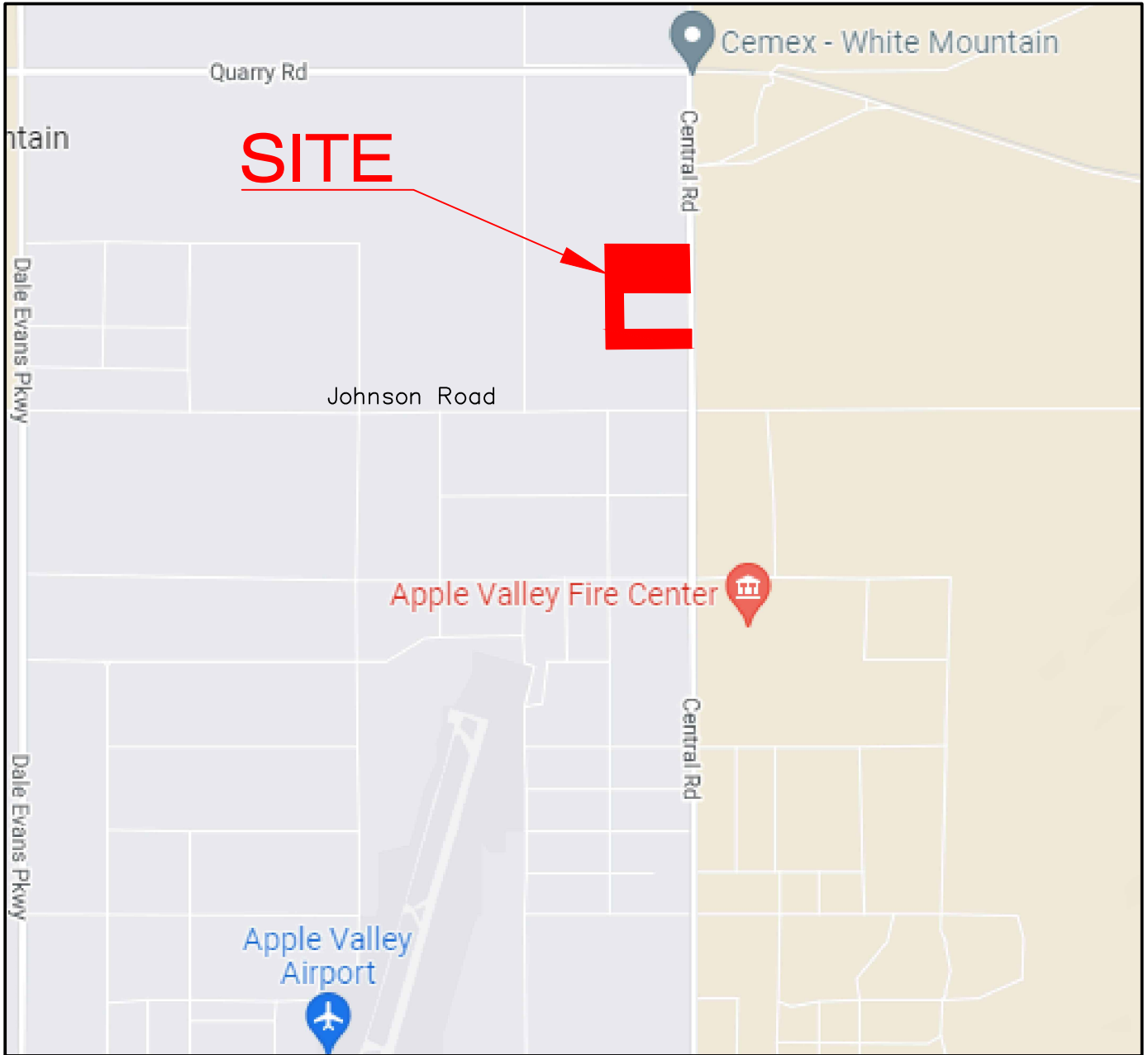

Latitude

Longitude

34.607346

-117.173220

DATE: 06/29/2023

DRAWN BY: DWL

CHECKED BY: DWL

SCALE: NTS

LOCATION MAP EXHIBIT A

**30 ACRE INDUSTRIAL SITE
Town of Apple Valley CA
APN: 0463-491-09**





Legend

- | | |
|--|--|
| Zoning | <ul style="list-style-type: none"> Town Boundary Sphere of Influence Parcels (A-1) Airport Overlay District (A-2) Airport Overlay District (F-H) Flood Hazard Overlay District (FH-L) Flood Hazard Lake Overlay District High Desert Corridor (Future) |
| <ul style="list-style-type: none"> (R-VLD) Very Low Density Residential (1du/5 or more gross acres) (R-A) Residential Agriculture (1du/2.5 gross acres) (R-LD) Low Density Residential (1 du/2.5 to 5 gross acres) (R-E) Estate Residential (1 du/1 to 2.5 gross acres) (RE-3/4) Estate Residential 3/4 (1 du/0.75 net acre) (R-EQ) Equestrian Residential (1 du/0.4 to 0.9 net acre) (R-SF) Single Family Residential (1du/0.4 to 0.9 net acre) (R-M) Multi-Family Residential (2 to 20 du/net acre) (MHP) Mobile Home Park (PRD) Planned Residential Development (C-G) General Commercial (C-V) Village Commercial (C-S) Service Commercial (O-P) Office Professional (C-R) Regional Commercial (I-P) Planned Industrial (I-RE) Resource Extraction (P-F) Public Facilities (OS-C) Open Space Conservation (OS-R) Open Space Recreation (M-U) Mixed Use (SP) Specific Plan (I-G) | |

DATE: 006/29/2023
DRAWN BY: DWL
CHECKED BY: DWL
SCALE: NTS

**LAND USE MAP
EXHIBIT B**

**30 ACRE INDUSTRIAL SITE
Town of Apple Valley CA
APN: 0463-491-09**

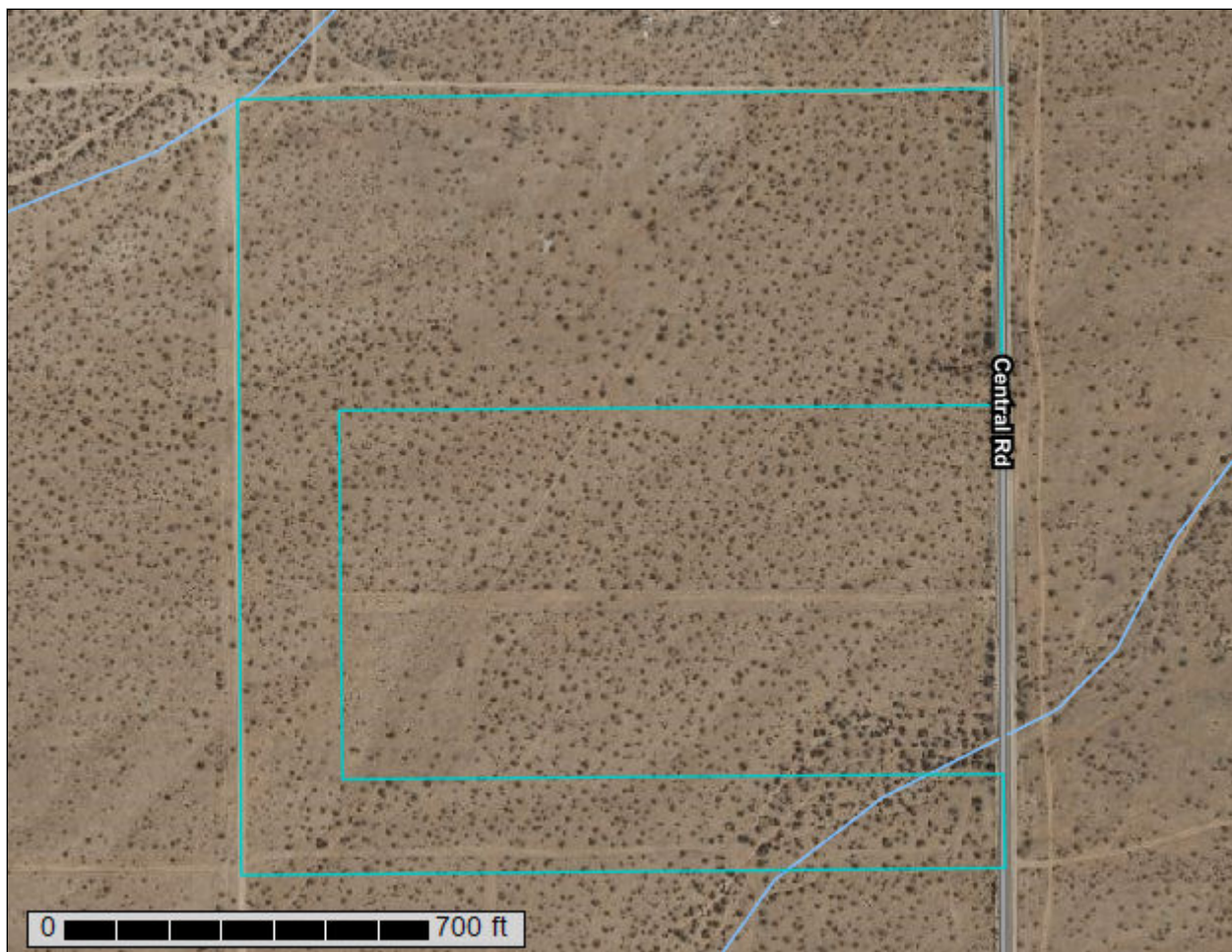

EXHIBIT C



A product of the National Cooperative Soil Survey, a joint effort of the United States Department of Agriculture and other Federal agencies, State agencies including the Agricultural Experiment Stations, and local participants

Custom Soil Resource Report for San Bernardino County, California, Mojave River Area CENTRAL AND CORDOVA



Preface

Soil surveys contain information that affects land use planning in survey areas. They highlight soil limitations that affect various land uses and provide information about the properties of the soils in the survey areas. Soil surveys are designed for many different users, including farmers, ranchers, foresters, agronomists, urban planners, community officials, engineers, developers, builders, and home buyers. Also, conservationists, teachers, students, and specialists in recreation, waste disposal, and pollution control can use the surveys to help them understand, protect, or enhance the environment.

Various land use regulations of Federal, State, and local governments may impose special restrictions on land use or land treatment. Soil surveys identify soil properties that are used in making various land use or land treatment decisions. The information is intended to help the land users identify and reduce the effects of soil limitations on various land uses. The landowner or user is responsible for identifying and complying with existing laws and regulations.

Although soil survey information can be used for general farm, local, and wider area planning, onsite investigation is needed to supplement this information in some cases. Examples include soil quality assessments (<http://www.nrcs.usda.gov/wps/portal/nrcs/main/soils/health/>) and certain conservation and engineering applications. For more detailed information, contact your local USDA Service Center (<https://offices.sc.egov.usda.gov/locator/app?agency=nrcs>) or your NRCS State Soil Scientist (http://www.nrcs.usda.gov/wps/portal/nrcs/detail/soils/contactus/?cid=nrcs142p2_053951).

Great differences in soil properties can occur within short distances. Some soils are seasonally wet or subject to flooding. Some are too unstable to be used as a foundation for buildings or roads. Clayey or wet soils are poorly suited to use as septic tank absorption fields. A high water table makes a soil poorly suited to basements or underground installations.

The National Cooperative Soil Survey is a joint effort of the United States Department of Agriculture and other Federal agencies, State agencies including the Agricultural Experiment Stations, and local agencies. The Natural Resources Conservation Service (NRCS) has leadership for the Federal part of the National Cooperative Soil Survey.

Information about soils is updated periodically. Updated information is available through the NRCS Web Soil Survey, the site for official soil survey information.

The U.S. Department of Agriculture (USDA) prohibits discrimination in all its programs and activities on the basis of race, color, national origin, age, disability, and where applicable, sex, marital status, familial status, parental status, religion, sexual orientation, genetic information, political beliefs, reprisal, or because all or a part of an individual's income is derived from any public assistance program. (Not all prohibited bases apply to all programs.) Persons with disabilities who require

alternative means for communication of program information (Braille, large print, audiotape, etc.) should contact USDA's TARGET Center at (202) 720-2600 (voice and TDD). To file a complaint of discrimination, write to USDA, Director, Office of Civil Rights, 1400 Independence Avenue, S.W., Washington, D.C. 20250-9410 or call (800) 795-3272 (voice) or (202) 720-6382 (TDD). USDA is an equal opportunity provider and employer.

Contents

Preface	2
Soil Map	5
Soil Map.....	6
Legend.....	7
Map Unit Legend.....	9
Map Unit Descriptions.....	9
San Bernardino County, California, Mojave River Area.....	11
118—CAJON-ARIZO COMPLEX, 2 TO 15 PERCENT SLOPES*.....	11
133—HELENDALE-BRYMAN LOAMY SANDS, 2 TO 5 PERCENT SLOPES*.....	12
References	15

Soil Map

The soil map section includes the soil map for the defined area of interest, a list of soil map units on the map and extent of each map unit, and cartographic symbols displayed on the map. Also presented are various metadata about data used to produce the map, and a description of each soil map unit.

Custom Soil Resource Report Soil Map

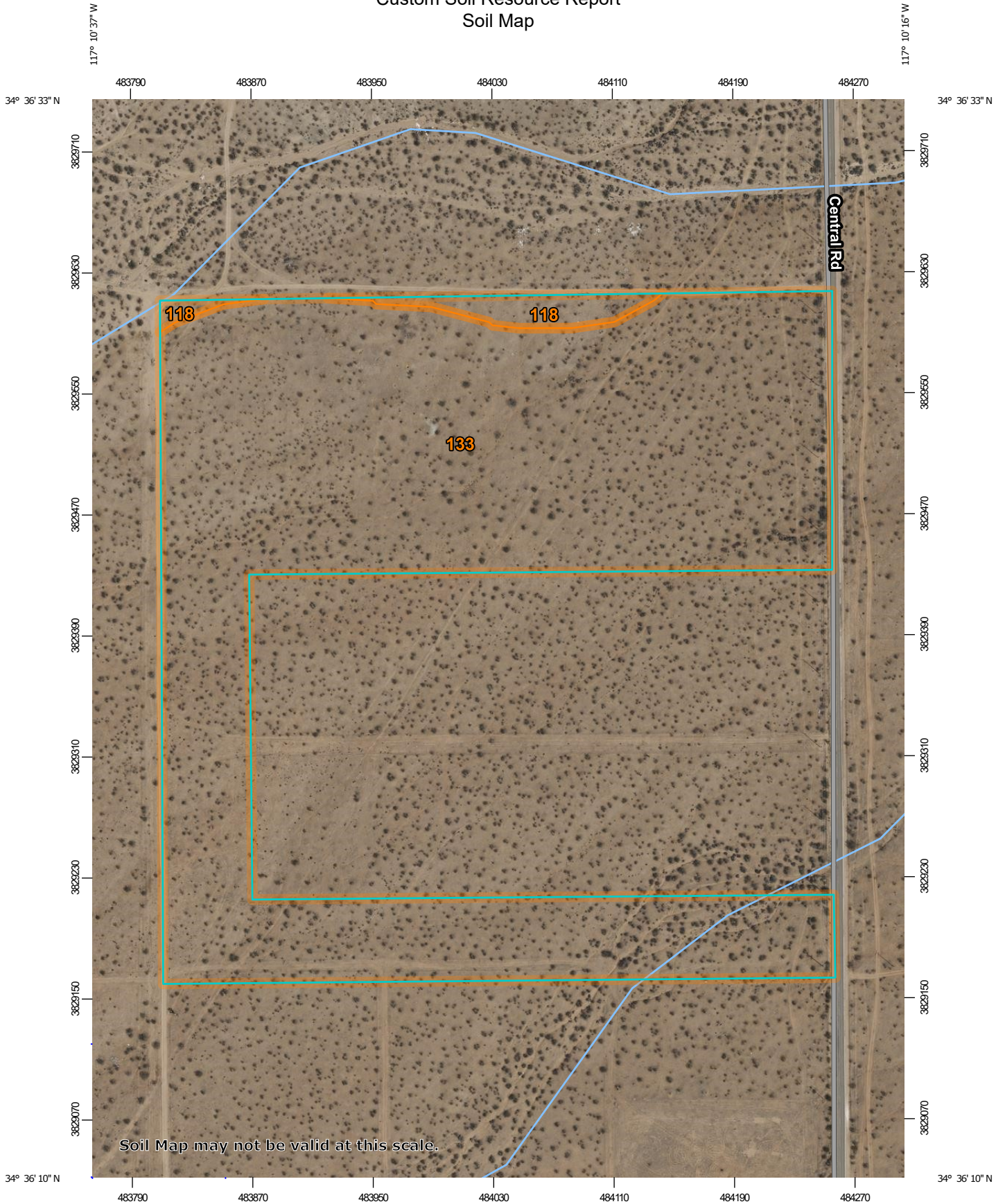

Map Scale: 1:3,480 if printed on A portrait (8.5" x 11") sheet.

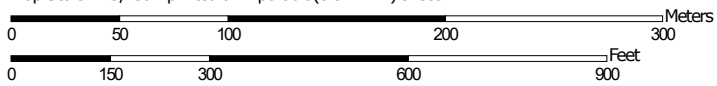

Map projection: Web Mercator Corner coordinates: WGS84 Edge tics: UTM Zone 11N WGS84

MAP LEGEND

Area of Interest (AOI)

 Area of Interest (AOI)

Soils

 Soil Map Unit Polygons

 Soil Map Unit Lines

 Soil Map Unit Points

Special Point Features





-  Blowout
-  Borrow Pit
-  Clay Spot
-  Closed Depression
-  Gravel Pit
-  Gravelly Spot
-  Landfill
-  Lava Flow
-  Marsh or swamp
-  Mine or Quarry
-  Miscellaneous Water
-  Perennial Water
-  Rock Outcrop
-  Saline Spot
-  Sandy Spot
-  Severely Eroded Spot
-  Sinkhole
-  Slide or Slip
-  Sodic Spot

-  Spoil Area
-  Stony Spot
-  Very Stony Spot
-  Wet Spot
-  Other
-  Special Line Features

Water Features

 Streams and Canals

Transportation

-  Rails
-  Interstate Highways
-  US Routes
-  Major Roads
-  Local Roads

Background

 Aerial Photography

MAP INFORMATION

The soil surveys that comprise your AOI were mapped at 1:24,000.

Warning: Soil Map may not be valid at this scale.

Enlargement of maps beyond the scale of mapping can cause misunderstanding of the detail of mapping and accuracy of soil line placement. The maps do not show the small areas of contrasting soils that could have been shown at a more detailed scale.

Please rely on the bar scale on each map sheet for map measurements.

Source of Map: Natural Resources Conservation Service
 Web Soil Survey URL:
 Coordinate System: Web Mercator (EPSG:3857)

Maps from the Web Soil Survey are based on the Web Mercator projection, which preserves direction and shape but distorts distance and area. A projection that preserves area, such as the Albers equal-area conic projection, should be used if more accurate calculations of distance or area are required.

This product is generated from the USDA-NRCS certified data as of the version date(s) listed below.

Soil Survey Area: San Bernardino County, California, Mojave River Area
 Survey Area Data: Version 14, Sep 1, 2022

Soil map units are labeled (as space allows) for map scales 1:50,000 or larger.

Date(s) aerial images were photographed: Mar 17, 2022—Jun 12, 2022

The orthophoto or other base map on which the soil lines were compiled and digitized probably differs from the background

MAP LEGEND

MAP INFORMATION

imagery displayed on these maps. As a result, some minor shifting of map unit boundaries may be evident.

Map Unit Legend

Map Unit Symbol	Map Unit Name	Acres in AOI	Percent of AOI
118 GROUP A	CAJON-ARIZO COMPLEX, 2 TO 15 PERCENT SLOPES*	0.8	2.7%
133 GROUP A & C	HELENDALE-BRYMAN LOAMY SANDS, 2 TO 5 PERCENT SLOPES*	28.7	97.3%
Totals for Area of Interest		29.5	100.0%

Map Unit Descriptions

The map units delineated on the detailed soil maps in a soil survey represent the soils or miscellaneous areas in the survey area. The map unit descriptions, along with the maps, can be used to determine the composition and properties of a unit.

A map unit delineation on a soil map represents an area dominated by one or more major kinds of soil or miscellaneous areas. A map unit is identified and named according to the taxonomic classification of the dominant soils. Within a taxonomic class there are precisely defined limits for the properties of the soils. On the landscape, however, the soils are natural phenomena, and they have the characteristic variability of all natural phenomena. Thus, the range of some observed properties may extend beyond the limits defined for a taxonomic class. Areas of soils of a single taxonomic class rarely, if ever, can be mapped without including areas of other taxonomic classes. Consequently, every map unit is made up of the soils or miscellaneous areas for which it is named and some minor components that belong to taxonomic classes other than those of the major soils.

Most minor soils have properties similar to those of the dominant soil or soils in the map unit, and thus they do not affect use and management. These are called noncontrasting, or similar, components. They may or may not be mentioned in a particular map unit description. Other minor components, however, have properties and behavioral characteristics divergent enough to affect use or to require different management. These are called contrasting, or dissimilar, components. They generally are in small areas and could not be mapped separately because of the scale used. Some small areas of strongly contrasting soils or miscellaneous areas are identified by a special symbol on the maps. If included in the database for a given area, the contrasting minor components are identified in the map unit descriptions along with some characteristics of each. A few areas of minor components may not have been observed, and consequently they are not mentioned in the descriptions, especially where the pattern was so complex that it was impractical to make enough observations to identify all the soils and miscellaneous areas on the landscape.

The presence of minor components in a map unit in no way diminishes the usefulness or accuracy of the data. The objective of mapping is not to delineate pure taxonomic classes but rather to separate the landscape into landforms or landform segments that have similar use and management requirements. The delineation of such segments on the map provides sufficient information for the

Custom Soil Resource Report

development of resource plans. If intensive use of small areas is planned, however, onsite investigation is needed to define and locate the soils and miscellaneous areas.

An identifying symbol precedes the map unit name in the map unit descriptions. Each description includes general facts about the unit and gives important soil properties and qualities.

Soils that have profiles that are almost alike make up a *soil series*. Except for differences in texture of the surface layer, all the soils of a series have major horizons that are similar in composition, thickness, and arrangement.

Soils of one series can differ in texture of the surface layer, slope, stoniness, salinity, degree of erosion, and other characteristics that affect their use. On the basis of such differences, a soil series is divided into *soil phases*. Most of the areas shown on the detailed soil maps are phases of soil series. The name of a soil phase commonly indicates a feature that affects use or management. For example, Alpha silt loam, 0 to 2 percent slopes, is a phase of the Alpha series.

Some map units are made up of two or more major soils or miscellaneous areas. These map units are complexes, associations, or undifferentiated groups.

A *complex* consists of two or more soils or miscellaneous areas in such an intricate pattern or in such small areas that they cannot be shown separately on the maps. The pattern and proportion of the soils or miscellaneous areas are somewhat similar in all areas. Alpha-Beta complex, 0 to 6 percent slopes, is an example.

An *association* is made up of two or more geographically associated soils or miscellaneous areas that are shown as one unit on the maps. Because of present or anticipated uses of the map units in the survey area, it was not considered practical or necessary to map the soils or miscellaneous areas separately. The pattern and relative proportion of the soils or miscellaneous areas are somewhat similar. Alpha-Beta association, 0 to 2 percent slopes, is an example.

An *undifferentiated group* is made up of two or more soils or miscellaneous areas that could be mapped individually but are mapped as one unit because similar interpretations can be made for use and management. The pattern and proportion of the soils or miscellaneous areas in a mapped area are not uniform. An area can be made up of only one of the major soils or miscellaneous areas, or it can be made up of all of them. Alpha and Beta soils, 0 to 2 percent slopes, is an example.

Some surveys include *miscellaneous areas*. Such areas have little or no soil material and support little or no vegetation. Rock outcrop is an example.

San Bernardino County, California, Mojave River Area

118—CAJON-ARIZO COMPLEX, 2 TO 15 PERCENT SLOPES*

Map Unit Setting

National map unit symbol: hkrq
Elevation: 2,800 to 3,300 feet
Mean annual precipitation: 3 to 6 inches
Mean annual air temperature: 59 to 66 degrees F
Frost-free period: 180 to 290 days
Farmland classification: Not prime farmland

Map Unit Composition

Cajon, gravelly surface, and similar soils: 55 percent
Arizo and similar soils: 30 percent
Minor components: 15 percent
Estimates are based on observations, descriptions, and transects of the mapunit.

Description of Cajon, Gravelly Surface

Setting

Landform: Alluvial fans
Landform position (two-dimensional): Backslope
Landform position (three-dimensional): Tread
Down-slope shape: Linear
Across-slope shape: Linear
Parent material: Alluvium derived from granite sources

Typical profile

H1 - 0 to 6 inches: gravelly sand
H2 - 6 to 60 inches: gravelly sand

Properties and qualities

Slope: 2 to 15 percent
Depth to restrictive feature: More than 80 inches
Drainage class: Somewhat excessively drained
Capacity of the most limiting layer to transmit water (Ksat): High to very high (5.95 to 19.98 in/hr)
Depth to water table: More than 80 inches
Frequency of flooding: Rare
Frequency of ponding: None
Calcium carbonate, maximum content: 1 percent
Available water supply, 0 to 60 inches: Very low (about 3.0 inches)

Interpretive groups

Land capability classification (irrigated): 4s
Land capability classification (nonirrigated): 7e
Hydrologic Soil Group: A
Ecological site: R030XF028CA - COBBLY SANDY
Hydric soil rating: No

Description of Arizo

Setting

Landform: Alluvial fans
Landform position (two-dimensional): Backslope

Custom Soil Resource Report

Landform position (three-dimensional): Tread
Down-slope shape: Linear
Across-slope shape: Linear
Parent material: Alluvium derived from granite sources

Typical profile

H1 - 0 to 6 inches: gravelly loamy sand
H2 - 6 to 60 inches: extremely gravelly loamy coarse sand

Properties and qualities

Slope: 2 to 9 percent
Depth to restrictive feature: More than 80 inches
Drainage class: Excessively drained
Capacity of the most limiting layer to transmit water (Ksat): High to very high (5.95 to 19.98 in/hr)
Depth to water table: More than 80 inches
Frequency of flooding: OccasionalNone
Frequency of ponding: None
Calcium carbonate, maximum content: 15 percent
Maximum salinity: Nonsaline to very slightly saline (0.0 to 2.0 mmhos/cm)
Available water supply, 0 to 60 inches: Low (about 3.1 inches)

Interpretive groups

Land capability classification (irrigated): None specified
Land capability classification (nonirrigated): 7w
Hydrologic Soil Group: A
Ecological site: R030XF025CA - GRAVELLY COARSE LOAMY
Hydric soil rating: No

Minor Components

Helendale

Percent of map unit: 4 percent
Hydric soil rating: No

Bryman

Percent of map unit: 4 percent
Hydric soil rating: No

Joshua

Percent of map unit: 4 percent
Hydric soil rating: No

Cajon, clayey substratum

Percent of map unit: 3 percent

133—HELENDALE-BRYMAN LOAMY SANDS, 2 TO 5 PERCENT SLOPES*

Map Unit Setting

National map unit symbol: hks6

Custom Soil Resource Report

Elevation: 2,500 to 4,000 feet
Mean annual precipitation: 3 to 6 inches
Mean annual air temperature: 59 to 63 degrees F
Frost-free period: 180 to 280 days
Farmland classification: Prime farmland if irrigated

Map Unit Composition

Helendale and similar soils: 50 percent
Bryman and similar soils: 35 percent
Minor components: 15 percent
Estimates are based on observations, descriptions, and transects of the mapunit.

Description of Helendale

Setting

Landform: Fan remnants
Landform position (two-dimensional): Backslope
Landform position (three-dimensional): Side slope
Down-slope shape: Linear
Across-slope shape: Linear
Parent material: Alluvium derived from granite sources

Typical profile

H1 - 0 to 6 inches: loamy sand
H2 - 6 to 30 inches: sandy loam
H3 - 30 to 66 inches: sandy loam
H4 - 66 to 99 inches: loamy sand

Properties and qualities

Slope: 2 to 5 percent
Depth to restrictive feature: More than 80 inches
Drainage class: Well drained
Capacity of the most limiting layer to transmit water (Ksat): High (1.98 to 5.95 in/hr)
Depth to water table: More than 80 inches
Frequency of flooding: None
Frequency of ponding: None
Calcium carbonate, maximum content: 5 percent
Maximum salinity: Nonsaline to very slightly saline (0.0 to 2.0 mmhos/cm)
Available water supply, 0 to 60 inches: Low (about 5.8 inches)

Interpretive groups

Land capability classification (irrigated): 2e
Land capability classification (nonirrigated): 7e
Hydrologic Soil Group: A
Ecological site: R030XF012CA - Sandy
Hydric soil rating: No

Description of Bryman

Setting

Landform: Fan remnants
Landform position (two-dimensional): Backslope
Landform position (three-dimensional): Side slope
Down-slope shape: Linear
Across-slope shape: Linear
Parent material: Alluvium derived from granite sources

Custom Soil Resource Report

Typical profile

H1 - 0 to 8 inches: loamy sand
H2 - 8 to 12 inches: sandy loam
H3 - 12 to 44 inches: sandy clay loam
H4 - 44 to 60 inches: loamy sand

Properties and qualities

Slope: 2 to 5 percent
Depth to restrictive feature: More than 80 inches
Drainage class: Well drained
Capacity of the most limiting layer to transmit water (Ksat): Moderately high (0.20 to 0.57 in/hr)
Depth to water table: More than 80 inches
Frequency of flooding: None
Frequency of ponding: None
Calcium carbonate, maximum content: 5 percent
Maximum salinity: Nonsaline to very slightly saline (0.0 to 2.0 mmhos/cm)
Available water supply, 0 to 60 inches: Moderate (about 7.3 inches)

Interpretive groups

Land capability classification (irrigated): 2e
Land capability classification (nonirrigated): 7e
Hydrologic Soil Group: C
Ecological site: R030XF012CA - Sandy
Hydric soil rating: No

Minor Components

Cajon

Percent of map unit: 5 percent
Hydric soil rating: No

Mohave variant

Percent of map unit: 5 percent
Hydric soil rating: No

Unnamed soils

Percent of map unit: 5 percent
Hydric soil rating: No

References

- American Association of State Highway and Transportation Officials (AASHTO). 2004. Standard specifications for transportation materials and methods of sampling and testing. 24th edition.
- American Society for Testing and Materials (ASTM). 2005. Standard classification of soils for engineering purposes. ASTM Standard D2487-00.
- Cowardin, L.M., V. Carter, F.C. Golet, and E.T. LaRoe. 1979. Classification of wetlands and deep-water habitats of the United States. U.S. Fish and Wildlife Service FWS/OBS-79/31.
- Federal Register. July 13, 1994. Changes in hydric soils of the United States.
- Federal Register. September 18, 2002. Hydric soils of the United States.
- Hurt, G.W., and L.M. Vasilas, editors. Version 6.0, 2006. Field indicators of hydric soils in the United States.
- National Research Council. 1995. Wetlands: Characteristics and boundaries.
- Soil Survey Division Staff. 1993. Soil survey manual. Soil Conservation Service. U.S. Department of Agriculture Handbook 18. http://www.nrcs.usda.gov/wps/portal/nrcs/detail/national/soils/?cid=nrcs142p2_054262
- Soil Survey Staff. 1999. Soil taxonomy: A basic system of soil classification for making and interpreting soil surveys. 2nd edition. Natural Resources Conservation Service, U.S. Department of Agriculture Handbook 436. http://www.nrcs.usda.gov/wps/portal/nrcs/detail/national/soils/?cid=nrcs142p2_053577
- Soil Survey Staff. 2010. Keys to soil taxonomy. 11th edition. U.S. Department of Agriculture, Natural Resources Conservation Service. http://www.nrcs.usda.gov/wps/portal/nrcs/detail/national/soils/?cid=nrcs142p2_053580
- Tiner, R.W., Jr. 1985. Wetlands of Delaware. U.S. Fish and Wildlife Service and Delaware Department of Natural Resources and Environmental Control, Wetlands Section.
- United States Army Corps of Engineers, Environmental Laboratory. 1987. Corps of Engineers wetlands delineation manual. Waterways Experiment Station Technical Report Y-87-1.
- United States Department of Agriculture, Natural Resources Conservation Service. National forestry manual. http://www.nrcs.usda.gov/wps/portal/nrcs/detail/soils/home/?cid=nrcs142p2_053374
- United States Department of Agriculture, Natural Resources Conservation Service. National range and pasture handbook. <http://www.nrcs.usda.gov/wps/portal/nrcs/detail/national/landuse/rangepasture/?cid=stelprdb1043084>

Custom Soil Resource Report

United States Department of Agriculture, Natural Resources Conservation Service. National soil survey handbook, title 430-VI. http://www.nrcs.usda.gov/wps/portal/nrcs/detail/soils/scientists/?cid=nrcs142p2_054242

United States Department of Agriculture, Natural Resources Conservation Service. 2006. Land resource regions and major land resource areas of the United States, the Caribbean, and the Pacific Basin. U.S. Department of Agriculture Handbook 296. http://www.nrcs.usda.gov/wps/portal/nrcs/detail/national/soils/?cid=nrcs142p2_053624

United States Department of Agriculture, Soil Conservation Service. 1961. Land capability classification. U.S. Department of Agriculture Handbook 210. http://www.nrcs.usda.gov/Internet/FSE_DOCUMENTS/nrcs142p2_052290.pdf

Curve (I) Numbers of Hydrologic Soil-Cover Complexes For Pervious Areas-AMC II					
Cover Type (3)	Quality of Cover (2)	Soil Group			
		A	B	C	D
<u>NATURAL COVERS -</u>					
Barren (Rockland, eroded and graded land)		78	86	91	93
Chaparral, Broadleaf (Manzonita, ceanothus and scrub oak)	Poor	53	70	80	85
	Fair	40	63	75	81
	Good	31	57	71	78
Chaparral, Narrowleaf (Chamise and redshank)	Poor	71	82	88	91
	Fair	55	72	81	86
Grass, Annual or Perennial	Poor	67	78	86	89
	Fair	50	69	79	84
	Good	38	61	74	80
Meadows or Cienegas (Areas with seasonally high water table, principal vegetation is sod forming grass)	Poor	63	77	85	88
	Fair	51	70	80	84
	Good	30	58	71	78
Open Brush (Soft wood shrubs - buckwheat, sage, etc.)	Poor	62	76	84	88
	Fair	46	66	77	83
	Good	41	63	75	81
Woodland (Coniferous or broadleaf trees predominate. Canopy density is at least 50 percent.)	Poor	45	66	77	83
	Fair	36	60	73	79
	Good	25	55	70	77
Woodland, Grass (Coniferous or broadleaf trees with canopy density from 20 to 50 percent)	Poor	57	73	82	86
	Fair	44	65	77	82
	Good	33	58	72	79
<u>URBAN COVERS -</u>					
Residential or Commercial Landscaping (Lawn, shrubs, etc.)	Good	32	56	69	75
Turf (Irrigated and mowed grass)	Poor	58	74	83	87
	Fair	44	65	77	82
	Good	33	58	72	79
<u>AGRICULTURAL COVERS -</u>					
Fallow (Land plowed but not tilled or seeded)		77	86	91	94

SAN BERNARDINO COUNTY
HYDROLOGY MANUAL

CURVE NUMBERS
FOR
PERVIOUS AREAS

Curve (I) Numbers of Hydrologic Soil-Cover Complexes For Pervious Areas-AMC II

Cover Type (3)	Quality of Cover (2)	Soil Group			
		A	B	C	D
AGRICULTURAL COVERS (Continued)					
Legumes, Close Seeded (Alfalfa, sweetclover, timothy, etc.)	Poor	66	77	85	89
	Good	58	72	81	85
Orchards, Evergreen (Citrus, avocados, etc.)	Poor	57	73	82	86
	Fair	44	65	77	82
	Good	33	58	72	79
Pasture, Dryland (Annual grasses)	Poor	68	79	86	89
	Fair	49	69	79	84
	Good	39	61	74	80
Pasture, Irrigated (Legumes and perennial grass)	Poor	58	74	83	87
	Fair	44	65	77	82
	Good	33	58	72	79
Row Crops (Field crops - tomatoes, sugar beets, etc.)	Poor	72	81	88	91
	Good	67	78	85	89
Small grain (Wheat, oats, barley, etc.)	Poor	65	76	84	88
	Good	63	75	83	87

Notes:

- All curve numbers are for Antecedent Moisture Condition (AMC) II.
- Quality of cover definitions:

Poor-Heavily grazed, regularly burned areas, or areas of high burn potential. Less than 50 percent of the ground surface is protected by plant cover or brush and tree canopy.

Fair-Moderate cover with 50 percent to 75 percent of the ground surface protected.

Good-Heavy or dense cover with more than 75 percent of the ground surface protected.
- See Figure C-2 for definition of cover types.

SAN BERNARDINO COUNTY
HYDROLOGY MANUAL

CURVE NUMBERS
FOR
PERVIOUS AREAS

ACTUAL IMPERVIOUS COVER		
Land Use (1)	Range-Percent	Recommended Value For Average Conditions-Percent (2)
Natural or Agriculture	0 - 0	0
Public Park	10 - 25	15
School	30 - 50	40
Single Family Residential: (3)		
2.5 acre lots	5 - 15	10
1 acre lots	10 - 25	20
2 dwellings/acre	20 - 40	30
3-4 dwellings/acre	30 - 50	40
5-7 dwellings/acre	35 - 55	50
8-10 dwellings/acre	50 - 70	60
More than 10 dwellings/acre	65 - 90	80
Multiple Family Residential:		
Condominiums	45 - 70	65
Apartments	65 - 90	80
Mobile Home Park	60 - 85	75
Commercial, Downtown Business or Industrial	80 - 100	90

Notes:

1. Land use should be based on ultimate development of the watershed. Long range master plans for the County and incorporated cities should be reviewed to insure reasonable land use assumptions.
2. Recommended values are based on average conditions which may not apply to a particular study area. The percentage impervious may vary greatly even on comparable sized lots due to differences in dwelling size, improvements, etc. Landscape practices should also be considered as it is common in some areas to use ornamental gravels underlain by impervious plastic materials in place of lawns and shrubs. A field investigation of a study area shall always be made, and a review of aerial photos, where available, may assist in estimating the percentage of impervious cover in developed areas.
3. For typical equestrian subdivisions increase impervious area 5 percent over the values recommended in the table above.

SAN BERNARDINO COUNTY
HYDROLOGY MANUAL

ACTUAL IMPERVIOUS COVER
FOR
DEVELOPED AREAS



POINT PRECIPITATION FREQUENCY ESTIMATES

Sanja Perica, Sarah Dietz, Sarah Heim, Lillian Hiner, Kazungu Maitaria, Deborah Martin, Sandra Pavlovic, Ishani Roy, Carl Trypaluk, Dale Unruh, Fenglin Yan, Michael Yekta, Tan Zhao, Geoffrey Bonnin, Daniel Brewer, Li-Chuan Chen, Tye Parzybok, John Yarchoan

NOAA, National Weather Service, Silver Spring, Maryland

[PF_tabular](#) | [PF_graphical](#) | [Maps & aeriels](#)

PF tabular

PDS-based point precipitation frequency estimates with 90% confidence intervals (in inches) ¹										
Duration	Average recurrence interval (years)									
	1	2	5	10	25	50	100	200	500	1000
5-min	0.082 (0.068-0.101)	0.115 (0.095-0.142)	0.162 (0.133-0.199)	0.201 (0.164-0.250)	0.259 (0.204-0.332)	0.306 (0.236-0.400)	0.356 (0.268-0.477)	0.410 (0.301-0.565)	0.489 (0.344-0.702)	0.554 (0.377-0.822)
10-min	0.118 (0.097-0.145)	0.166 (0.136-0.203)	0.232 (0.190-0.285)	0.289 (0.235-0.358)	0.371 (0.292-0.476)	0.438 (0.338-0.573)	0.510 (0.384-0.684)	0.588 (0.431-0.810)	0.701 (0.493-1.01)	0.794 (0.540-1.18)
15-min	0.143 (0.118-0.175)	0.200 (0.165-0.246)	0.280 (0.230-0.345)	0.349 (0.284-0.433)	0.448 (0.353-0.575)	0.530 (0.409-0.693)	0.617 (0.465-0.827)	0.711 (0.522-0.980)	0.848 (0.597-1.22)	0.960 (0.653-1.42)
30-min	0.196 (0.161-0.240)	0.275 (0.226-0.337)	0.385 (0.315-0.473)	0.479 (0.390-0.595)	0.616 (0.485-0.790)	0.727 (0.561-0.952)	0.847 (0.638-1.14)	0.977 (0.716-1.35)	1.16 (0.819-1.67)	1.32 (0.897-1.96)
60-min	0.249 (0.205-0.305)	0.349 (0.287-0.428)	0.488 (0.400-0.601)	0.608 (0.495-0.754)	0.781 (0.615-1.00)	0.923 (0.712-1.21)	1.08 (0.810-1.44)	1.24 (0.909-1.71)	1.48 (1.04-2.12)	1.67 (1.14-2.48)
2-hr	0.351 (0.289-0.431)	0.474 (0.390-0.582)	0.644 (0.528-0.793)	0.789 (0.642-0.980)	0.997 (0.785-1.28)	1.17 (0.899-1.52)	1.34 (1.01-1.80)	1.54 (1.13-2.12)	1.81 (1.27-2.60)	2.03 (1.38-3.02)
3-hr	0.426 (0.351-0.523)	0.568 (0.467-0.698)	0.763 (0.626-0.939)	0.929 (0.756-1.15)	1.16 (0.917-1.49)	1.36 (1.05-1.77)	1.56 (1.17-2.09)	1.77 (1.30-2.44)	2.08 (1.46-2.98)	2.32 (1.58-3.45)
6-hr	0.578 (0.476-0.709)	0.763 (0.627-0.937)	1.01 (0.831-1.25)	1.22 (0.997-1.52)	1.52 (1.20-1.95)	1.76 (1.36-2.31)	2.01 (1.52-2.70)	2.28 (1.67-3.14)	2.65 (1.86-3.80)	2.95 (2.01-4.38)
12-hr	0.740 (0.610-0.908)	0.982 (0.808-1.21)	1.31 (1.07-1.61)	1.58 (1.28-1.96)	1.96 (1.54-2.51)	2.26 (1.74-2.95)	2.57 (1.93-3.44)	2.89 (2.12-3.99)	3.35 (2.36-4.80)	3.71 (2.52-5.50)
24-hr	0.972 (0.862-1.12)	1.31 (1.16-1.50)	1.75 (1.55-2.02)	2.12 (1.86-2.47)	2.63 (2.23-3.17)	3.03 (2.51-3.72)	3.44 (2.79-4.33)	3.87 (3.05-5.01)	4.46 (3.37-6.02)	4.92 (3.60-6.88)
2-day	1.15 (1.02-1.32)	1.57 (1.39-1.81)	2.13 (1.88-2.46)	2.59 (2.27-3.01)	3.22 (2.73-3.88)	3.71 (3.08-4.56)	4.21 (3.41-5.30)	4.74 (3.73-6.13)	5.45 (4.12-7.36)	6.01 (4.39-8.40)
3-day	1.25 (1.11-1.44)	1.72 (1.52-1.98)	2.35 (2.08-2.72)	2.87 (2.51-3.34)	3.57 (3.03-4.30)	4.12 (3.42-5.06)	4.68 (3.79-5.89)	5.26 (4.14-6.81)	6.06 (4.58-8.18)	6.69 (4.88-9.34)
4-day	1.32 (1.17-1.52)	1.83 (1.62-2.11)	2.50 (2.21-2.89)	3.06 (2.68-3.56)	3.81 (3.23-4.59)	4.39 (3.65-5.40)	4.99 (4.04-6.29)	5.61 (4.42-7.27)	6.46 (4.89-8.72)	7.13 (5.21-9.96)
7-day	1.44 (1.28-1.66)	1.98 (1.76-2.28)	2.70 (2.39-3.12)	3.29 (2.89-3.84)	4.11 (3.48-4.94)	4.74 (3.94-5.83)	5.39 (4.36-6.78)	6.06 (4.78-7.85)	6.98 (5.28-9.43)	7.71 (5.63-10.8)
10-day	1.52 (1.35-1.75)	2.09 (1.85-2.40)	2.84 (2.51-3.28)	3.46 (3.04-4.04)	4.33 (3.67-5.21)	5.00 (4.15-6.14)	5.68 (4.60-7.16)	6.40 (5.04-8.29)	7.39 (5.58-9.97)	8.16 (5.96-11.4)
20-day	1.75 (1.55-2.01)	2.40 (2.13-2.77)	3.29 (2.91-3.80)	4.03 (3.53-4.69)	5.06 (4.29-6.09)	5.87 (4.87-7.21)	6.70 (5.43-8.44)	7.58 (5.97-9.81)	8.78 (6.64-11.9)	9.73 (7.11-13.6)
30-day	1.98 (1.75-2.27)	2.73 (2.42-3.14)	3.75 (3.31-4.33)	4.61 (4.04-5.37)	5.82 (4.93-7.00)	6.77 (5.62-8.32)	7.76 (6.29-9.77)	8.80 (6.93-11.4)	10.2 (7.74-13.8)	11.4 (8.30-15.9)
45-day	2.32 (2.06-2.67)	3.22 (2.85-3.70)	4.44 (3.92-5.13)	5.48 (4.81-6.39)	6.96 (5.90-8.38)	8.15 (6.76-10.0)	9.38 (7.60-11.8)	10.7 (8.42-13.8)	12.5 (9.45-16.9)	13.9 (10.2-19.5)
60-day	2.55 (2.26-2.93)	3.52 (3.12-4.05)	4.87 (4.30-5.62)	6.02 (5.28-7.01)	7.67 (6.50-9.23)	9.00 (7.47-11.1)	10.4 (8.43-13.1)	11.9 (9.37-15.4)	14.0 (10.6-18.9)	15.7 (11.4-21.9)

¹ Precipitation frequency (PF) estimates in this table are based on frequency analysis of partial duration series (PDS). Numbers in parenthesis are PF estimates at lower and upper bounds of the 90% confidence interval. The probability that precipitation frequency estimates (for a given duration and average recurrence interval) will be greater than the upper bound (or less than the lower bound) is 5%. Estimates at upper bounds are not checked against probable maximum precipitation (PMP) estimates and may be higher than currently valid PMP values. Please refer to NOAA Atlas 14 document for more information.

[Back to Top](#)

PF graphical

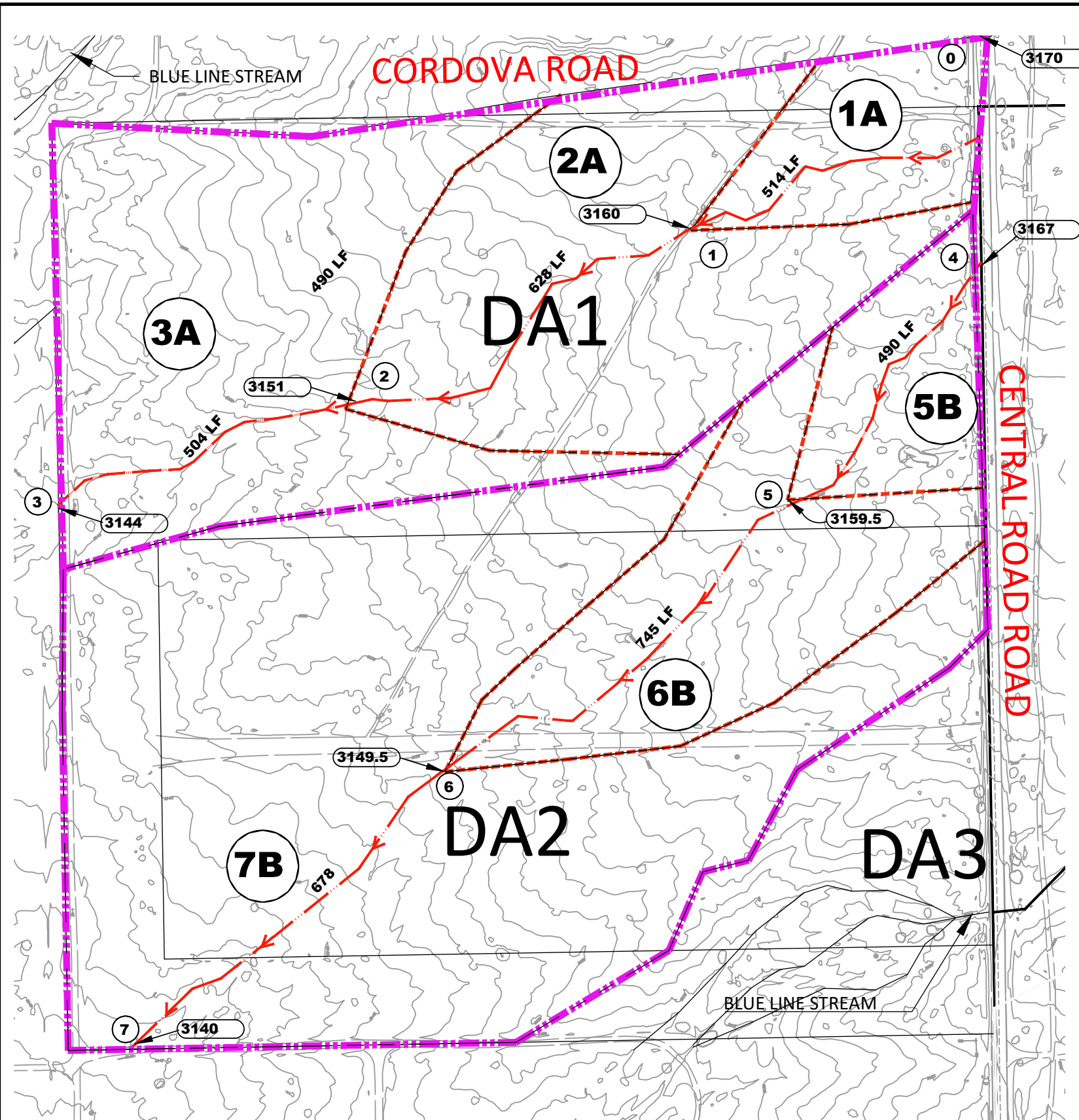

LEGEND:

- SUB-AREA NUMBER** **DRAINAGE MANAGEMENT SUB-AREA**
- ##** **NODE #**
- XXXX** **ELEVATION**
- OVERALL BOUNDARY**
- SUBAREA BOUNDARY**
- SUBAREA FLOWLINE**
- EG** **EXISTING GRADE**
- FG** **FINISH GRADE**
- FS** **FINISH SURFACE**
- FF** **FINISH FLOOR**
- IE** **INVERT ELEVATION**

ACERAGE

DA	SF	Acres
DA1		
1A	94577.14	2.17
2A	347904.5	7.99
3A	384122.1	8.82
	Total	18.98
DA2		
1B	92627.41	2.13
2B	227058.7	5.21
3B	827134.9	18.99
	Total	26.33

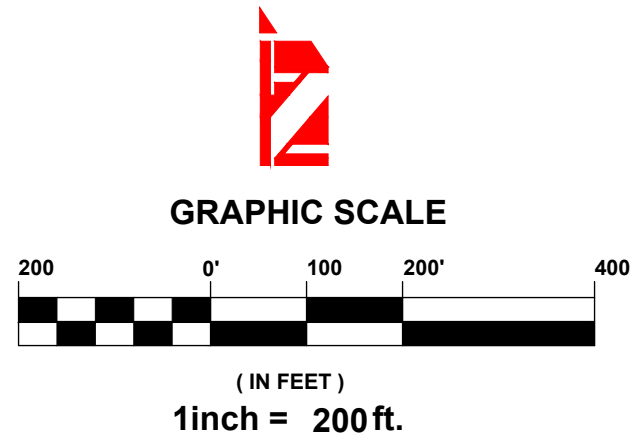

PRE DEVELOPED HYDROLOGY

**FOR:
AV 3PL CENTER LLC**

**IN THE
TOWN OF APPLE VALLEY, CA**

**APN:
0463-491-09**

RED BRICK SOLUTION

CONSULTING ENGINEERS & ARCHITECTS

EXHIBIT F

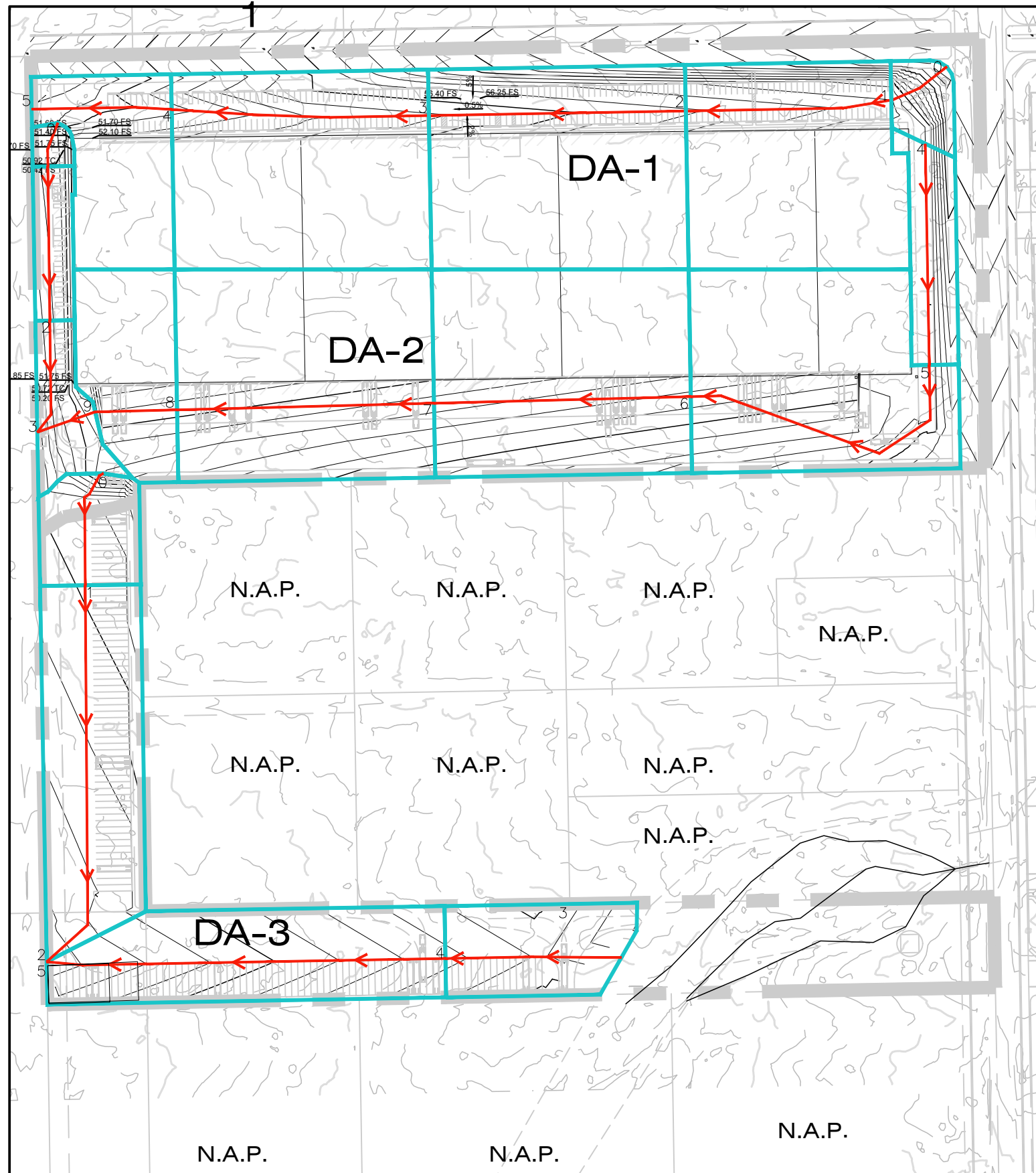

30 ACRE DEVELOPED HYDROLOGY

Area	Upper Node	Lower Node	Upper Elev	Lower Elev	Flow Length	Acres	Volume
DA-1							2.5684
Initial	0	1	3167	3158	101.72	0.28	
Sub Area 1	1	2	3158	3155.8	320.8	2.46	
Sub Area 2	2	3	3155.8	3153.8	400	2.89	
Sub Area 3	3	4	3153.8	3150.7	400.62	2.82	
Sub Area 4	4	5	3150.7	3148.5	217.89	1.19	
TOTAL						9.64	
DA-2							2.992
Initial	0	1	3149	3148.5	70.6	0.09	
Sub Area 1	1	2	3148.5	3148	240	0.34	
Sub Area 2	2	3	3148	3147.5	181	0.48	
Confluence							
Initial	4	5	3159	3158.5	242.81	0.58	
Sub Area 3	5	6	3158.5	3155	489.53	2.75	
Sub Area 4	6	7	3155	3152	400	2.94	
Sub Area 5	7	8	3152	3149.5	400	3	
Sub Area 6	8	9	3149.5	3149	127.46	1.05	
Sub Area 7	9	3	3149	3147.5	95.4		
Confluence							
TOTAL						11.23	
DA-3							1.4254
Initial	0	1	3152	3145.3	185.48	0.6	
Sub Area 1	1	2	3145.3	3141	614.2	1.96	
Confluence							
Initial	3	4	3149	3147.7	248.18	0.9	
Sub Area 1	4	5	3147.7	3141	621	1.89	
Confluence	5	2					
TOTAL						5.35 TOTAL VOL	6.9858
GRAND TOTAL						26.22	



GRAPHIC SCALE

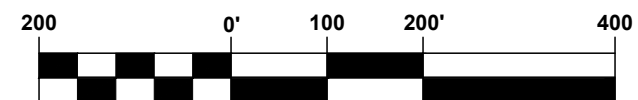

(IN FEET)
1 inch = 200 ft.

DEVELOPED HYDROLOGY

FOR:
AV 3PL CENTER LLC

IN THE
TOWN OF APPLE VALLEY, CA

APN:
0463-491-09

RED BRICK SOLUTION

CONSULTING ENGINEERS & ARCHITECTS

EXHIBITG

APPENDIX B

Calculations

100 Year 1 Hour Pre-Developed Rational Method DA1-DA2
100-Year 24-hour Pre-Developed Unit Hydrograph Method DA1-DA3

100 Year 1 Hour Post-Developed Rational Method DA1-DA3
100-Year 24-hour Post-Developed Unit Hydrograph Method DA1-DA3

San Bernardino County Rational Hydrology Program

(Hydrology Manual Date - August 1986)

CIVILCADD/CIVILDESIGN Engineering Software, (c) 1989-2018 Version 9.0
Rational Hydrology Study Date: 08/31/23

**PRE-DEVELOPED 100-YEAR 1-HOUR
DA1 30-ac
AMC II**

Program License Serial Number 6434

***** Hydrology Study Control Information *****

Rational hydrology study storm event year is 100.0
Computed rainfall intensity:
Storm year = 100.00 1 hour rainfall = 1.080 (In.)
Slope used for rainfall intensity curve b = 0.7000
Soil antecedent moisture condition (AMC) = 2

Process from Point/Station 0.000 to Point/Station 1.000
**** INITIAL AREA EVALUATION ****

UNDEVELOPED (poor cover) subarea
Decimal fraction soil group A = 0.000
Decimal fraction soil group B = 0.000
Decimal fraction soil group C = 1.000
Decimal fraction soil group D = 0.000
SCS curve number for soil(AMC 2) = 86.00
Pervious ratio(Ap) = 1.0000 Max loss rate(Fm)= 0.265(In/Hr)
Initial subarea data:
Initial area flow distance = 514.000(Ft.)
Top (of initial area) elevation = 3170.000(Ft.)
Bottom (of initial area) elevation = 3160.000(Ft.)
Difference in elevation = 10.000(Ft.)
Slope = 0.01946 s(%)= 1.95
TC = k(0.525)*[(length^3)/(elevation change)]^0.2
Initial area time of concentration = 14.020 min.
Rainfall intensity = 2.988(In/Hr) for a 100.0 year storm
Effective runoff coefficient used for area (Q=KCIA) is C = 0.820
Subarea runoff = 5.318(CFS)
Total initial stream area = 2.170(Ac.)
Pervious area fraction = 1.000
Initial area Fm value = 0.265(In/Hr)

Process from Point/Station 1.000 to Point/Station 2.000
**** IMPROVED CHANNEL TRAVEL TIME ****

Upstream point elevation = 3160.000(Ft.)
Downstream point elevation = 3151.000(Ft.)
Channel length thru subarea = 628.000(Ft.)
Channel base width = 20.000(Ft.)

Slope or 'Z' of left channel bank = 30.000
 Slope or 'Z' of right channel bank = 30.000
 Estimated mean flow rate at midpoint of channel = 12.203 (CFS)
 Manning's 'N' = 0.033
 Maximum depth of channel = 1.000 (Ft.)
 Flow(q) thru subarea = 12.203 (CFS)
 Depth of flow = 0.247 (Ft.), Average velocity = 1.807 (Ft/s)
 Channel flow top width = 34.791 (Ft.)
 Flow Velocity = 1.81 (Ft/s)
 Travel time = 5.79 min.
 Time of concentration = 19.81 min.
 Critical depth = 0.203 (Ft.)
 Adding area flow to channel
 UNDEVELOPED (poor cover) subarea
 Decimal fraction soil group A = 0.000
 Decimal fraction soil group B = 0.000
 Decimal fraction soil group C = 1.000
 Decimal fraction soil group D = 0.000
 SCS curve number for soil(AMC 2) = 86.00
 Pervious ratio(Ap) = 1.0000 Max loss rate(Fm)= 0.265 (In/Hr)
 Rainfall intensity = 2.346 (In/Hr) for a 100.0 year storm
 Effective runoff coefficient used for area, (total area with modified
 rational method) (Q=KCIA) is C = 0.798
 Subarea runoff = 13.707 (CFS) for 7.990 (Ac.)
 Total runoff = 19.025 (CFS)
 Effective area this stream = 10.16 (Ac.)
 Total Study Area (Main Stream No. 1) = 10.16 (Ac.)
 Area averaged Fm value = 0.265 (In/Hr)
 Depth of flow = 0.313 (Ft.), Average velocity = 2.066 (Ft/s)
 Critical depth = 0.266 (Ft.)

++++++
 Process from Point/Station 2.000 to Point/Station 3.000
 **** IMPROVED CHANNEL TRAVEL TIME ****

Upstream point elevation = 3151.000 (Ft.)
 Downstream point elevation = 3144.000 (Ft.)
 Channel length thru subarea = 504.000 (Ft.)
 Channel base width = 20.000 (Ft.)
 Slope or 'Z' of left channel bank = 30.000
 Slope or 'Z' of right channel bank = 30.000
 Estimated mean flow rate at midpoint of channel = 25.011 (CFS)
 Manning's 'N' = 0.033
 Maximum depth of channel = 1.000 (Ft.)
 Flow(q) thru subarea = 25.011 (CFS)
 Depth of flow = 0.365 (Ft.), Average velocity = 2.214 (Ft/s)
 Channel flow top width = 41.898 (Ft.)
 Flow Velocity = 2.21 (Ft/s)
 Travel time = 3.79 min.
 Time of concentration = 23.61 min.
 Critical depth = 0.309 (Ft.)
 Adding area flow to channel
 UNDEVELOPED (poor cover) subarea
 Decimal fraction soil group A = 0.000
 Decimal fraction soil group B = 0.000
 Decimal fraction soil group C = 1.000
 Decimal fraction soil group D = 0.000
 SCS curve number for soil(AMC 2) = 86.00
 Pervious ratio(Ap) = 1.0000 Max loss rate(Fm)= 0.265 (In/Hr)
 Rainfall intensity = 2.075 (In/Hr) for a 100.0 year storm
 Effective runoff coefficient used for area, (total area with modified
 rational method) (Q=KCIA) is C = 0.785

Subarea runoff = 11.891(CFS) for 8.820(Ac.)
Total runoff = 30.917(CFS)
Effective area this stream = 18.98(Ac.)
Total Study Area (Main Stream No. 1) = 18.98(Ac.)
Area averaged Fm value = 0.265(In/Hr)
Depth of flow = 0.408(Ft.), Average velocity = 2.354(Ft/s)
Critical depth = 0.352(Ft.)
End of computations, Total Study Area = 18.98 (Ac.)

The following figures may

be used for a unit hydrograph study of the same area.

Note: These figures do not consider reduced effective area effects caused by confluences in the rational equation.

Area averaged pervious area fraction(Ap) = 1.000

Area averaged SCS curve number = 86.0

San Bernardino County Rational Hydrology Program

(Hydrology Manual Date - August 1986)

CIVILCADD/CIVILDESIGN Engineering Software, (c) 1989-2018 Version 9.0
Rational Hydrology Study Date: 08/31/23

**PRE-DEVELOPED 100-YEAR 1-HOUR
DA1 - 30 AC
AMCIII**

Program License Serial Number 6434

***** Hydrology Study Control Information *****

Rational hydrology study storm event year is 100.0
Computed rainfall intensity:
Storm year = 100.00 1 hour rainfall = 1.080 (In.)
Slope used for rainfall intensity curve b = 0.7000
Soil antecedent moisture condition (AMC) = 3

+++++
Process from Point/Station 0.000 to Point/Station 1.000
**** INITIAL AREA EVALUATION ****

UNDEVELOPED (poor cover) subarea
Decimal fraction soil group A = 0.000
Decimal fraction soil group B = 0.000
Decimal fraction soil group C = 1.000
Decimal fraction soil group D = 0.000
SCS curve number for soil(AMC 2) = 86.00
Adjusted SCS curve number for AMC 3 = 97.20
Pervious ratio(Ap) = 1.0000 Max loss rate(Fm)= 0.055(In/Hr)
Initial subarea data:
Initial area flow distance = 514.000(Ft.)
Top (of initial area) elevation = 3170.000(Ft.)
Bottom (of initial area) elevation = 3160.000(Ft.)
Difference in elevation = 10.000(Ft.)
Slope = 0.01946 s(%)= 1.95
TC = k(0.525)*[(length^3)/(elevation change)]^0.2
Initial area time of concentration = 14.020 min.
Rainfall intensity = 2.988(In/Hr) for a 100.0 year storm
Effective runoff coefficient used for area (Q=KCIA) is C = 0.883
Subarea runoff = 5.728(CFS)
Total initial stream area = 2.170(Ac.)
Pervious area fraction = 1.000
Initial area Fm value = 0.055(In/Hr)

+++++
Process from Point/Station 1.000 to Point/Station 2.000
**** IMPROVED CHANNEL TRAVEL TIME ****

Upstream point elevation = 3160.000(Ft.)
Downstream point elevation = 3151.000(Ft.)

Channel length thru subarea = 628.000(Ft.)
 Channel base width = 20.000(Ft.)
 Slope or 'Z' of left channel bank = 30.000
 Slope or 'Z' of right channel bank = 30.000
 Estimated mean flow rate at midpoint of channel = 13.429(CFS)
 Manning's 'N' = 0.033
 Maximum depth of channel = 1.000(Ft.)
 Flow(q) thru subarea = 13.429(CFS)
 Depth of flow = 0.260(Ft.), Average velocity = 1.861(Ft/s)
 Channel flow top width = 35.582(Ft.)
 Flow Velocity = 1.86(Ft/s)
 Travel time = 5.63 min.
 Time of concentration = 19.64 min.
 Critical depth = 0.215(Ft.)
 Adding area flow to channel
 UNDEVELOPED (poor cover) subarea
 Decimal fraction soil group A = 0.000
 Decimal fraction soil group B = 0.000
 Decimal fraction soil group C = 1.000
 Decimal fraction soil group D = 0.000
 SCS curve number for soil(AMC 2) = 86.00
 Adjusted SCS curve number for AMC 3 = 97.20
 Pervious ratio(Ap) = 1.0000 Max loss rate(Fm)= 0.055(In/Hr)
 Rainfall intensity = 2.360(In/Hr) for a 100.0 year storm
 Effective runoff coefficient used for area, (total area with modified
 rational method) (Q=KCIA) is C = 0.879
 Subarea runoff = 15.343(CFS) for 7.990(Ac.)
 Total runoff = 21.070(CFS)
 Effective area this stream = 10.16(Ac.)
 Total Study Area (Main Stream No. 1) = 10.16(Ac.)
 Area averaged Fm value = 0.055(In/Hr)
 Depth of flow = 0.331(Ft.), Average velocity = 2.129(Ft/s)
 Critical depth = 0.281(Ft.)

++++++
 Process from Point/Station 2.000 to Point/Station 3.000
 **** IMPROVED CHANNEL TRAVEL TIME ****

Upstream point elevation = 3151.000(Ft.)
 Downstream point elevation = 3144.000(Ft.)
 Channel length thru subarea = 504.000(Ft.)
 Channel base width = 20.000(Ft.)
 Slope or 'Z' of left channel bank = 30.000
 Slope or 'Z' of right channel bank = 30.000
 Estimated mean flow rate at midpoint of channel = 27.977(CFS)
 Manning's 'N' = 0.033
 Maximum depth of channel = 1.000(Ft.)
 Flow(q) thru subarea = 27.977(CFS)
 Depth of flow = 0.387(Ft.), Average velocity = 2.287(Ft/s)
 Channel flow top width = 43.219(Ft.)
 Flow Velocity = 2.29(Ft/s)
 Travel time = 3.67 min.
 Time of concentration = 23.32 min.
 Critical depth = 0.332(Ft.)
 Adding area flow to channel
 UNDEVELOPED (poor cover) subarea
 Decimal fraction soil group A = 0.000
 Decimal fraction soil group B = 0.000
 Decimal fraction soil group C = 1.000
 Decimal fraction soil group D = 0.000
 SCS curve number for soil(AMC 2) = 86.00
 Adjusted SCS curve number for AMC 3 = 97.20

Pervious ratio(A_p) = 1.0000 Max loss rate(F_m)= 0.055(In/Hr)
Rainfall intensity = 2.093(In/Hr) for a 100.0 year storm
Effective runoff coefficient used for area, (total area with modified
rational method) ($Q=KCIA$) is $C = 0.876$
Subarea runoff = 13.735(CFS) for 8.820(Ac.)
Total runoff = 34.805(CFS)
Effective area this stream = 18.98(Ac.)
Total Study Area (Main Stream No. 1) = 18.98(Ac.)
Area averaged F_m value = 0.055(In/Hr)
Depth of flow = 0.433(Ft.), Average velocity = 2.435(Ft/s)
Critical depth = 0.375(Ft.)
End of computations, Total Study Area = 18.98 (Ac.)

The following figures may

be used for a unit hydrograph study of the same area.

Note: These figures do not consider reduced effective area effects caused by confluences in the rational equation.

Area averaged pervious area fraction(A_p) = 1.000

Area averaged SCS curve number = 86.0

San Bernardino County Rational Hydrology Program

(Hydrology Manual Date - August 1986)

CIVILCADD/CIVILDESIGN Engineering Software, (c) 1989-2018 Version 9.0
Rational Hydrology Study Date: 08/31/23

DA2 - 30 AC
100 -YEAR 1 -HOUR
AMCIII
PRE-DEVELOPED

Program License Serial Number 6434

***** Hydrology Study Control Information *****

Rational hydrology study storm event year is 100.0
Computed rainfall intensity:
Storm year = 100.00 1 hour rainfall = 1.080 (In.)
Slope used for rainfall intensity curve b = 0.7000
Soil antecedent moisture condition (AMC) = 3

+++++
Process from Point/Station 0.000 to Point/Station 1.000
**** INITIAL AREA EVALUATION ****

UNDEVELOPED (poor cover) subarea
Decimal fraction soil group A = 0.000
Decimal fraction soil group B = 0.000
Decimal fraction soil group C = 1.000
Decimal fraction soil group D = 0.000
SCS curve number for soil(AMC 2) = 86.00
Adjusted SCS curve number for AMC 3 = 97.20
Pervious ratio(Ap) = 1.0000 Max loss rate(Fm)= 0.055(In/Hr)
Initial subarea data:
Initial area flow distance = 490.000(Ft.)
Top (of initial area) elevation = 3167.000(Ft.)
Bottom (of initial area) elevation = 3159.500(Ft.)
Difference in elevation = 7.500(Ft.)
Slope = 0.01531 s(%)= 1.53
TC = k(0.525)*[(length^3)/(elevation change)]^0.2
Initial area time of concentration = 14.430 min.
Rainfall intensity = 2.928(In/Hr) for a 100.0 year storm
Effective runoff coefficient used for area (Q=KCIA) is C = 0.883
Subarea runoff = 5.508(CFS)
Total initial stream area = 2.130(Ac.)
Pervious area fraction = 1.000
Initial area Fm value = 0.055(In/Hr)

+++++
Process from Point/Station 1.000 to Point/Station 2.000
**** IMPROVED CHANNEL TRAVEL TIME ****

Upstream point elevation = 3159.500(Ft.)

Downstream point elevation = 3149.500(Ft.)
 Channel length thru subarea = 745.000(Ft.)
 Channel base width = 20.000(Ft.)
 Slope or 'Z' of left channel bank = 30.000
 Slope or 'Z' of right channel bank = 30.000
 Estimated mean flow rate at midpoint of channel = 9.833(CFS)
 Manning's 'N' = 0.033
 Maximum depth of channel = 1.000(Ft.)
 Flow(q) thru subarea = 9.833(CFS)
 Depth of flow = 0.223(Ft.), Average velocity = 1.652(Ft/s)
 Channel flow top width = 33.378(Ft.)
 Flow Velocity = 1.65(Ft/s)
 Travel time = 7.51 min.
 Time of concentration = 21.94 min.
 Critical depth = 0.178(Ft.)
 Adding area flow to channel
 UNDEVELOPED (poor cover) subarea
 Decimal fraction soil group A = 0.000
 Decimal fraction soil group B = 0.000
 Decimal fraction soil group C = 1.000
 Decimal fraction soil group D = 0.000
 SCS curve number for soil(AMC 2) = 86.00
 Adjusted SCS curve number for AMC 3 = 97.20
 Pervious ratio(Ap) = 1.0000 Max loss rate(Fm)= 0.055(In/Hr)
 Rainfall intensity = 2.184(In/Hr) for a 100.0 year storm
 Effective runoff coefficient used for area, (total area with modified
 rational method) (Q=KCIA) is C = 0.877
 Subarea runoff = 8.552(CFS) for 5.210(Ac.)
 Total runoff = 14.060(CFS)
 Effective area this stream = 7.34(Ac.)
 Total Study Area (Main Stream No. 1) = 7.34(Ac.)
 Area averaged Fm value = 0.055(In/Hr)
 Depth of flow = 0.271(Ft.), Average velocity = 1.844(Ft/s)
 Critical depth = 0.221(Ft.)

++++++
 Process from Point/Station 2.000 to Point/Station 3.000
 **** IMPROVED CHANNEL TRAVEL TIME ****

Upstream point elevation = 3149.500(Ft.)
 Downstream point elevation = 3140.000(Ft.)
 Channel length thru subarea = 678.000(Ft.)
 Channel base width = 20.000(Ft.)
 Slope or 'Z' of left channel bank = 30.000
 Slope or 'Z' of right channel bank = 30.000
 Estimated mean flow rate at midpoint of channel = 28.886(CFS)
 Manning's 'N' = 0.033
 Maximum depth of channel = 1.000(Ft.)
 Flow(q) thru subarea = 28.886(CFS)
 Depth of flow = 0.393(Ft.), Average velocity = 2.316(Ft/s)
 Channel flow top width = 43.554(Ft.)
 Flow Velocity = 2.32(Ft/s)
 Travel time = 4.88 min.
 Time of concentration = 26.82 min.
 Critical depth = 0.336(Ft.)
 Adding area flow to channel
 UNDEVELOPED (poor cover) subarea
 Decimal fraction soil group A = 0.000
 Decimal fraction soil group B = 0.000
 Decimal fraction soil group C = 1.000
 Decimal fraction soil group D = 0.000
 SCS curve number for soil(AMC 2) = 86.00

Adjusted SCS curve number for AMC 3 = 97.20
Pervious ratio(A_p) = 1.0000 Max loss rate(F_m)= 0.055(In/Hr)
Rainfall intensity = 1.897(In/Hr) for a 100.0 year storm
Effective runoff coefficient used for area, (total area with modified
rational method) ($Q=KCIA$) is $C = 0.874$
Subarea runoff = 29.590(CFS) for 18.990(Ac.)
Total runoff = 43.650(CFS)
Effective area this stream = 26.33(Ac.)
Total Study Area (Main Stream No. 1) = 26.33(Ac.)
Area averaged F_m value = 0.055(In/Hr)
Depth of flow = 0.485(Ft.), Average velocity = 2.603(Ft/s)
Critical depth = 0.426(Ft.)
End of computations, Total Study Area = 26.33 (Ac.)
The following figures may
be used for a unit hydrograph study of the same area.
Note: These figures do not consider reduced effective area
effects caused by confluences in the rational equation.

Area averaged pervious area fraction(A_p) = 1.000
Area averaged SCS curve number = 86.0

Unit Hydrograph Analysis
Copyright (c) CIVILCADD/CIVILDESIGN, 1989 - 2018, Version 9.0

Study date 08/31/23

+++++

San Bernardino County Synthetic Unit Hydrology Method
Manual date - August 1986

Program License Serial Number 6434

**PRE-DEVELOPED DA1 30-AC
100-YEAR 24-HOUR
AMC II**

Storm Event Year = 100

Antecedent Moisture Condition = 2

English (in-lb) Input Units Used

English Rainfall Data (Inches) Input Values Used

English Units used in output format

Area averaged rainfall intensity isohyetal data:

Sub-Area (Ac.)	Duration (hours)	Isohyetal (In)
Rainfall data for year 100		
18.98	1	1.08

Rainfall data for year 100
18.98 6 2.01

Rainfall data for year 100
18.98 24 3.44

+++++

***** Area-averaged max loss rate, Fm *****

SCS curve No. (AMCII)	SCS curve NO. (AMC 2)	Area (Ac.)	Area Fraction	Fp (Fig C6) (In/Hr)	Ap (dec.)	Fm (In/Hr)
86.0	86.0	18.98	1.000	0.265	1.000	0.265

Area-averaged adjusted loss rate Fm (In/Hr) = 0.265

***** Area-Averaged low loss rate fraction, Yb *****

Area (Ac.)	Area Fract	SCS CN (AMC2)	SCS CN (AMC2)	S	Pervious Yield Fr
18.98	1.000	86.0	86.0	1.63	0.595

Area-averaged catchment yield fraction, Y = 0.595
 Area-averaged low loss fraction, Yb = 0.405
 User entry of time of concentration = 0.394 (hours)
 ++++++
 Watershed area = 18.98 (Ac.)
 Catchment Lag time = 0.315 hours
 Unit interval = 5.000 minutes
 Unit interval percentage of lag time = 26.4718
 Hydrograph baseflow = 0.00 (CFS)
 Average maximum watershed loss rate (Fm) = 0.265 (In/Hr)
 Average low loss rate fraction (Yb) = 0.405 (decimal)
 DESERT S-Graph Selected
 Computed peak 5-minute rainfall = 0.512 (In)
 Computed peak 30-minute rainfall = 0.877 (In)
 Specified peak 1-hour rainfall = 1.080 (In)
 Computed peak 3-hour rainfall = 1.581 (In)
 Specified peak 6-hour rainfall = 2.010 (In)
 Specified peak 24-hour rainfall = 3.440 (In)

Rainfall depth area reduction factors:
 Using a total area of 18.98 (Ac.) (Ref: fig. E-4)

5-minute factor = 0.999	Adjusted rainfall = 0.512 (In)
30-minute factor = 0.999	Adjusted rainfall = 0.876 (In)
1-hour factor = 0.999	Adjusted rainfall = 1.079 (In)
3-hour factor = 1.000	Adjusted rainfall = 1.580 (In)
6-hour factor = 1.000	Adjusted rainfall = 2.010 (In)
24-hour factor = 1.000	Adjusted rainfall = 3.440 (In)

U n i t H y d r o g r a p h

+++++

Interval Number	'S' Graph Mean values	Unit Hydrograph (CFS)
	(K = 229.54 (CFS))	
1	1.463	3.358
2	7.294	13.384
3	22.868	35.750
4	44.952	50.690
5	58.857	31.919
6	67.278	19.328
7	73.355	13.950
8	77.960	10.569
9	81.522	8.177
10	84.411	6.632
11	86.904	5.723
12	88.936	4.664
13	90.526	3.650
14	91.949	3.265
15	93.188	2.844
16	94.249	2.436
17	95.151	2.070
18	95.945	1.823
19	96.632	1.577
20	97.192	1.285
21	97.663	1.082

263	0.0056	0.0023	0.0033
264	0.0056	0.0023	0.0033
265	0.0055	0.0022	0.0033
266	0.0055	0.0022	0.0033
267	0.0054	0.0022	0.0032
268	0.0054	0.0022	0.0032
269	0.0053	0.0022	0.0032
270	0.0053	0.0021	0.0031
271	0.0053	0.0021	0.0031
272	0.0052	0.0021	0.0031
273	0.0052	0.0021	0.0031
274	0.0051	0.0021	0.0031
275	0.0051	0.0021	0.0030
276	0.0051	0.0020	0.0030
277	0.0050	0.0020	0.0030
278	0.0050	0.0020	0.0030
279	0.0049	0.0020	0.0029
280	0.0049	0.0020	0.0029
281	0.0049	0.0020	0.0029
282	0.0048	0.0020	0.0029
283	0.0048	0.0020	0.0029
284	0.0048	0.0019	0.0028
285	0.0047	0.0019	0.0028
286	0.0047	0.0019	0.0028
287	0.0047	0.0019	0.0028
288	0.0047	0.0019	0.0028

Total soil rain loss = 1.17(In)
Total effective rainfall = 2.27(In)
Peak flow rate in flood hydrograph = 32.53(CFS)

+++++

24 - H O U R S T O R M
R u n o f f H y d r o g r a p h

Hydrograph in 5 Minute intervals ((CFS))

Time(h+m)	Volume Ac.Ft	Q(CFS)	0	10.0	20.0	30.0	40.0
0+ 5	0.0001	0.01	Q				
0+10	0.0004	0.05	Q				
0+15	0.0014	0.14	Q				
0+20	0.0033	0.28	Q				
0+25	0.0059	0.37	Q				
0+30	0.0089	0.43	Q				
0+35	0.0121	0.47	Q				
0+40	0.0155	0.50	Q				
0+45	0.0191	0.52	Q				
0+50	0.0229	0.54	Q				
0+55	0.0267	0.56	Q				
1+ 0	0.0307	0.57	Q				
1+ 5	0.0347	0.59	Q				
1+10	0.0388	0.60	Q				
1+15	0.0430	0.61	Q				
1+20	0.0473	0.62	Q				
1+25	0.0516	0.62	Q				
1+30	0.0559	0.63	Q				
1+35	0.0603	0.64	Q				
1+40	0.0647	0.64	Q				
1+45	0.0692	0.65	Q				
1+50	0.0737	0.65	Q				

1+55	0.0782	0.66	Q				
2+ 0	0.0828	0.66	Q				
2+ 5	0.0874	0.67	Q				
2+10	0.0920	0.67	QV				
2+15	0.0966	0.67	QV				
2+20	0.1013	0.68	QV				
2+25	0.1060	0.68	QV				
2+30	0.1107	0.68	QV				
2+35	0.1154	0.69	QV				
2+40	0.1202	0.69	QV				
2+45	0.1250	0.69	QV				
2+50	0.1298	0.70	QV				
2+55	0.1346	0.70	QV				
3+ 0	0.1394	0.70	QV				
3+ 5	0.1442	0.70	QV				
3+10	0.1491	0.71	QV				
3+15	0.1540	0.71	QV				
3+20	0.1589	0.71	QV				
3+25	0.1638	0.71	QV				
3+30	0.1687	0.72	QV				
3+35	0.1737	0.72	QV				
3+40	0.1786	0.72	QV				
3+45	0.1836	0.73	Q V				
3+50	0.1887	0.73	Q V				
3+55	0.1937	0.73	Q V				
4+ 0	0.1987	0.73	Q V				
4+ 5	0.2038	0.74	Q V				
4+10	0.2089	0.74	Q V				
4+15	0.2140	0.74	Q V				
4+20	0.2192	0.75	Q V				
4+25	0.2243	0.75	Q V				
4+30	0.2295	0.75	Q V				
4+35	0.2347	0.76	Q V				
4+40	0.2400	0.76	Q V				
4+45	0.2452	0.76	Q V				
4+50	0.2505	0.77	Q V				
4+55	0.2558	0.77	Q V				
5+ 0	0.2611	0.77	Q V				
5+ 5	0.2664	0.78	Q V				
5+10	0.2718	0.78	Q V				
5+15	0.2772	0.78	Q V				
5+20	0.2826	0.79	Q V				
5+25	0.2881	0.79	Q V				
5+30	0.2935	0.79	Q V				
5+35	0.2990	0.80	Q V				
5+40	0.3045	0.80	Q V				
5+45	0.3101	0.80	Q V				
5+50	0.3156	0.81	Q V				
5+55	0.3212	0.81	Q V				
6+ 0	0.3269	0.82	Q V				
6+ 5	0.3325	0.82	Q V				
6+10	0.3382	0.82	Q V				
6+15	0.3439	0.83	Q V				
6+20	0.3496	0.83	Q V				
6+25	0.3554	0.84	Q V				
6+30	0.3612	0.84	Q V				
6+35	0.3670	0.85	Q V				
6+40	0.3729	0.85	Q V				
6+45	0.3788	0.85	Q V				
6+50	0.3847	0.86	Q V				
6+55	0.3906	0.86	Q V				
7+ 0	0.3966	0.87	Q V				
7+ 5	0.4026	0.87	Q V				

7+10	0.4087	0.88	Q	V				
7+15	0.4147	0.88	Q	V				
7+20	0.4209	0.89	Q	V				
7+25	0.4270	0.89	Q	V				
7+30	0.4332	0.90	Q	V				
7+35	0.4394	0.90	Q	V				
7+40	0.4457	0.91	Q	V				
7+45	0.4519	0.91	Q	V				
7+50	0.4583	0.92	Q	V				
7+55	0.4646	0.92	Q	V				
8+ 0	0.4710	0.93	Q	V				
8+ 5	0.4775	0.93	Q	V				
8+10	0.4839	0.94	Q	V				
8+15	0.4905	0.95	Q	V				
8+20	0.4970	0.95	Q	V				
8+25	0.5036	0.96	Q	V				
8+30	0.5103	0.96	Q	V				
8+35	0.5170	0.97	Q	V				
8+40	0.5237	0.98	Q	V				
8+45	0.5305	0.98	Q	V				
8+50	0.5373	0.99	Q	V				
8+55	0.5441	1.00	Q	V				
9+ 0	0.5510	1.00	Q	V				
9+ 5	0.5580	1.01	Q	V				
9+10	0.5650	1.02	Q	V				
9+15	0.5721	1.02	Q	V				
9+20	0.5792	1.03	Q	V				
9+25	0.5863	1.04	Q	V				
9+30	0.5935	1.05	Q	V				
9+35	0.6008	1.05	Q	V				
9+40	0.6081	1.06	Q	V				
9+45	0.6155	1.07	Q	V				
9+50	0.6229	1.08	Q	V				
9+55	0.6304	1.09	Q	V				
10+ 0	0.6379	1.10	Q	V				
10+ 5	0.6455	1.10	Q	V				
10+10	0.6532	1.11	Q	V				
10+15	0.6609	1.12	Q	V				
10+20	0.6687	1.13	Q	V				
10+25	0.6766	1.14	Q	V				
10+30	0.6845	1.15	Q	V				
10+35	0.6925	1.16	Q	V				
10+40	0.7005	1.17	Q	V				
10+45	0.7087	1.18	Q	V				
10+50	0.7169	1.19	Q	V				
10+55	0.7252	1.20	Q	V				
11+ 0	0.7335	1.21	Q	V				
11+ 5	0.7419	1.22	Q	V				
11+10	0.7505	1.24	Q	V				
11+15	0.7591	1.25	Q	V				
11+20	0.7677	1.26	Q	V				
11+25	0.7765	1.27	Q	V				
11+30	0.7854	1.29	Q	V				
11+35	0.7943	1.30	Q	V				
11+40	0.8034	1.31	Q	V				
11+45	0.8125	1.33	Q	V				
11+50	0.8217	1.34	Q	V				
11+55	0.8311	1.36	Q	V				
12+ 0	0.8405	1.37	Q	V				
12+ 5	0.8501	1.39	Q	V				
12+10	0.8597	1.39	Q	V				
12+15	0.8692	1.39	Q	V				
12+20	0.8786	1.37	Q	V				

12+25	0.8880	1.36	Q	V				
12+30	0.8975	1.37	Q	V				
12+35	0.9070	1.38	Q	V				
12+40	0.9165	1.39	Q	V				
12+45	0.9262	1.40	Q	V				
12+50	0.9360	1.42	Q	V				
12+55	0.9459	1.44	Q	V				
13+ 0	0.9559	1.46	Q	V				
13+ 5	0.9661	1.48	Q	V				
13+10	0.9764	1.50	Q	V				
13+15	0.9869	1.52	Q	V				
13+20	0.9976	1.55	Q	V				
13+25	1.0084	1.57	Q	V				
13+30	1.0195	1.60	Q	V				
13+35	1.0307	1.63	Q	V				
13+40	1.0421	1.66	Q	V				
13+45	1.0538	1.69	Q	V				
13+50	1.0657	1.73	Q	V				
13+55	1.0778	1.76	Q	V				
14+ 0	1.0902	1.80	Q	V				
14+ 5	1.1029	1.84	Q	V				
14+10	1.1159	1.89	Q	V				
14+15	1.1292	1.93	Q	V				
14+20	1.1429	1.98	Q	V				
14+25	1.1569	2.03	Q	V				
14+30	1.1713	2.09	Q	V				
14+35	1.1861	2.15	Q	V				
14+40	1.2014	2.22	Q	V				
14+45	1.2171	2.29	Q	V				
14+50	1.2335	2.37	Q	V				
14+55	1.2503	2.45	Q	V				
15+ 0	1.2679	2.54	Q	V				
15+ 5	1.2861	2.65	Q	V				
15+10	1.3051	2.76	Q	V				
15+15	1.3250	2.89	Q	V				
15+20	1.3459	3.03	Q	V				
15+25	1.3679	3.19	Q	V				
15+30	1.3909	3.35	Q	V				
15+35	1.4149	3.48	Q	V				
15+40	1.4398	3.62	Q	V				
15+45	1.4664	3.86	Q	V				
15+50	1.4956	4.23	Q	V				
15+55	1.5287	4.81	Q	V				
16+ 0	1.5693	5.89	Q	V				
16+ 5	1.6325	9.18		Q	V			
16+10	1.7425	15.98			Q	V		
16+15	1.9282	26.97				V	Q	
16+20	2.1523	32.53				V		Q
16+25	2.3102	22.93				Q	V	
16+30	2.4207	16.05			Q		V	
16+35	2.5080	12.67			Q		V	
16+40	2.5801	10.47			Q		V	
16+45	2.6409	8.84			Q		V	
16+50	2.6938	7.67			Q		V	
16+55	2.7409	6.84			Q		V	
17+ 0	2.7822	6.00			Q		V	
17+ 5	2.8184	5.25			Q		V	
17+10	2.8516	4.82		Q			V	
17+15	2.8818	4.40		Q			V	
17+20	2.9094	4.01		Q			V	
17+25	2.9346	3.66		Q			V	
17+30	2.9579	3.38		Q			V	
17+35	2.9793	3.11		Q			V	

17+40	2.9989	2.84	Q				V	
17+45	3.0169	2.62	Q				V	
17+50	3.0332	2.36	Q				V	
17+55	3.0485	2.22	Q				V	
18+ 0	3.0635	2.18	Q				V	
18+ 5	3.0781	2.13	Q				V	
18+10	3.0923	2.06	Q				V	
18+15	3.1059	1.98	Q				V	
18+20	3.1185	1.83	Q				V	
18+25	3.1306	1.76	Q				V	
18+30	3.1422	1.69	Q				V	
18+35	3.1524	1.48	Q				V	
18+40	3.1623	1.44	Q				V	
18+45	3.1720	1.40	Q				V	
18+50	3.1814	1.37	Q				V	
18+55	3.1907	1.34	Q				V	
19+ 0	3.1997	1.31	Q				V	
19+ 5	3.2085	1.28	Q				V	
19+10	3.2172	1.26	Q				V	
19+15	3.2257	1.24	Q				V	
19+20	3.2341	1.21	Q				V	
19+25	3.2423	1.19	Q				V	
19+30	3.2503	1.17	Q				V	
19+35	3.2582	1.15	Q				V	
19+40	3.2660	1.13	Q				V	
19+45	3.2737	1.11	Q				V	
19+50	3.2812	1.10	Q				V	
19+55	3.2887	1.08	Q				V	
20+ 0	3.2960	1.06	Q				V	
20+ 5	3.3032	1.05	Q				V	
20+10	3.3103	1.03	Q				V	
20+15	3.3173	1.02	Q				V	
20+20	3.3242	1.00	Q				V	
20+25	3.3311	0.99	Q				V	
20+30	3.3378	0.98	Q				V	
20+35	3.3444	0.97	Q				V	
20+40	3.3510	0.95	Q				V	
20+45	3.3575	0.94	Q				V	
20+50	3.3639	0.93	Q				V	
20+55	3.3702	0.92	Q				V	
21+ 0	3.3765	0.91	Q				V	
21+ 5	3.3826	0.90	Q				V	
21+10	3.3888	0.89	Q				V	
21+15	3.3948	0.88	Q				V	
21+20	3.4008	0.87	Q				V	
21+25	3.4067	0.86	Q				V	
21+30	3.4125	0.85	Q				V	
21+35	3.4183	0.84	Q				V	
21+40	3.4241	0.83	Q				V	
21+45	3.4297	0.82	Q				V	
21+50	3.4354	0.82	Q				V	
21+55	3.4409	0.81	Q				V	
22+ 0	3.4464	0.80	Q				V	
22+ 5	3.4519	0.79	Q				V	
22+10	3.4573	0.79	Q				V	
22+15	3.4627	0.78	Q				V	
22+20	3.4680	0.77	Q				V	
22+25	3.4733	0.77	Q				V	
22+30	3.4785	0.76	Q				V	
22+35	3.4837	0.75	Q				V	
22+40	3.4888	0.75	Q				V	
22+45	3.4939	0.74	Q				V	
22+50	3.4989	0.73	Q				V	

22+55	3.5040	0.73	Q				V
23+ 0	3.5089	0.72	Q				V
23+ 5	3.5139	0.72	Q				V
23+10	3.5187	0.71	Q				V
23+15	3.5236	0.70	Q				V
23+20	3.5284	0.70	Q				V
23+25	3.5332	0.69	Q				V
23+30	3.5379	0.69	Q				V
23+35	3.5427	0.68	Q				V
23+40	3.5473	0.68	Q				V
23+45	3.5520	0.67	Q				V
23+50	3.5566	0.67	Q				V
23+55	3.5612	0.66	Q				V
24+ 0	3.5657	0.66	Q				V
24+ 5	3.5702	0.65	Q				V
24+10	3.5743	0.61	Q				V
24+15	3.5778	0.50	Q				V
24+20	3.5803	0.36	Q				V
24+25	3.5822	0.27	Q				V
24+30	3.5836	0.22	Q				V
24+35	3.5848	0.18	Q				V
24+40	3.5858	0.15	Q				V
24+45	3.5867	0.12	Q				V
24+50	3.5874	0.10	Q				V
24+55	3.5880	0.09	Q				V
25+ 0	3.5885	0.07	Q				V
25+ 5	3.5889	0.06	Q				V
25+10	3.5893	0.05	Q				V
25+15	3.5896	0.04	Q				V
25+20	3.5898	0.04	Q				V
25+25	3.5901	0.03	Q				V
25+30	3.5902	0.03	Q				V
25+35	3.5904	0.02	Q				V
25+40	3.5905	0.02	Q				V
25+45	3.5906	0.02	Q				V
25+50	3.5907	0.01	Q				V
25+55	3.5908	0.01	Q				V
26+ 0	3.5909	0.01	Q				V
26+ 5	3.5909	0.01	Q				V
26+10	3.5909	0.01	Q				V
26+15	3.5910	0.00	Q				V
26+20	3.5910	0.00	Q				V
26+25	3.5910	0.00	Q				V

U n i t H y d r o g r a p h A n a l y s i s
 Copyright (c) CIVILCADD/CIVILDESIGN, 1989 - 2018, Version 9.0

Study date 08/31/23

+++++

San Bernardino County Synthetic Unit Hydrology Method
 Manual date - August 1986

Program License Serial Number 6434

PRE-DEVELOPED DA1 30-AC
100-YEAR 24-HOUR
AMC III

Storm Event Year = 100

Antecedent Moisture Condition = 3

English (in-lb) Input Units Used

English Rainfall Data (Inches) Input Values Used

English Units used in output format

Area averaged rainfall intensity isohyetal data:

Sub-Area (Ac.)	Duration (hours)	Isohyetal (In)
Rainfall data for year 100		
18.98	1	1.08

Rainfall data for year 100		
18.98	6	2.01

Rainfall data for year 100		
18.98	24	3.44

+++++

***** Area-averaged max loss rate, Fm *****

SCS curve No. (AMCII)	SCS curve NO. (AMC 3)	Area (Ac.)	Area Fraction	Fp (Fig C6) (In/Hr)	Ap (dec.)	Fm (In/Hr)
86.0	97.2	18.98	1.000	0.055	1.000	0.055

Area-averaged adjusted loss rate Fm (In/Hr) = 0.055

***** Area-Averaged low loss rate fraction, Yb *****

Area	Area	SCS CN	SCS CN	S	Pervious
------	------	--------	--------	---	----------

(Ac.)	Fract	(AMC2)	(AMC3)		Yield Fr
18.98	1.000	86.0	97.2	0.29	0.906

Area-averaged catchment yield fraction, Y = 0.906
Area-averaged low loss fraction, Yb = 0.094
User entry of time of concentration = 0.389 (hours)
+++++
Watershed area = 18.98 (Ac.)
Catchment Lag time = 0.311 hours
Unit interval = 5.000 minutes
Unit interval percentage of lag time = 26.7872
Hydrograph baseflow = 0.00 (CFS)
Average maximum watershed loss rate (Fm) = 0.055 (In/Hr)
Average low loss rate fraction (Yb) = 0.094 (decimal)
DESERT S-Graph Selected
Computed peak 5-minute rainfall = 0.512 (In)
Computed peak 30-minute rainfall = 0.877 (In)
Specified peak 1-hour rainfall = 1.080 (In)
Computed peak 3-hour rainfall = 1.581 (In)
Specified peak 6-hour rainfall = 2.010 (In)
Specified peak 24-hour rainfall = 3.440 (In)

Rainfall depth area reduction factors:
Using a total area of 18.98 (Ac.) (Ref: fig. E-4)

5-minute factor = 0.999	Adjusted rainfall = 0.512 (In)
30-minute factor = 0.999	Adjusted rainfall = 0.876 (In)
1-hour factor = 0.999	Adjusted rainfall = 1.079 (In)
3-hour factor = 1.000	Adjusted rainfall = 1.580 (In)
6-hour factor = 1.000	Adjusted rainfall = 2.010 (In)
24-hour factor = 1.000	Adjusted rainfall = 3.440 (In)

U n i t H y d r o g r a p h

+++++

Interval	'S' Graph	Unit Hydrograph
Number	Mean values	((CFS))

(K = 229.54 (CFS))

1	1.488	3.416
2	7.462	13.712
3	23.556	36.943
4	45.684	50.791
5	59.408	31.504
6	67.732	19.106
7	73.751	13.815
8	78.315	10.475
9	81.839	8.091
10	84.712	6.594
11	87.186	5.679
12	89.173	4.560
13	90.750	3.621
14	92.158	3.231
15	93.390	2.828
16	94.417	2.358
17	95.323	2.081
18	96.088	1.756
19	96.773	1.571
20	97.302	1.216
21	97.761	1.053
22	98.059	0.685

23	98.337	0.637
24	98.654	0.728
25	98.975	0.738
26	99.297	0.738
27	99.560	0.605
28	99.729	0.387
29	99.896	0.384
30	100.000	0.238

Total soil rain loss = 0.27(In)
Total effective rainfall = 3.17(In)
Peak flow rate in flood hydrograph = 36.03(CFS)

+++++
24 - H O U R S T O R M
R u n o f f H y d r o g r a p h

Hydrograph in 5 Minute intervals ((CFS))

Time(h+m)	Volume	Ac.Ft	Q(CFS)	0	10.0	20.0	30.0	40.0
0+ 5	0.0001		0.01	Q				
0+10	0.0006		0.07	Q				
0+15	0.0022		0.23	Q				
0+20	0.0052		0.44	Q				
0+25	0.0092		0.57	Q				
0+30	0.0137		0.66	Q				
0+35	0.0186		0.72	Q				
0+40	0.0239		0.76	Q				
0+45	0.0294		0.80	Q				
0+50	0.0351		0.83	Q				
0+55	0.0410		0.86	Q				
1+ 0	0.0471		0.88	Q				
1+ 5	0.0532		0.90	Q				
1+10	0.0595		0.91	Q				
1+15	0.0659		0.93	Q				
1+20	0.0724		0.94	Q				
1+25	0.0790		0.95	Q				
1+30	0.0856		0.96	Q				
1+35	0.0923		0.97	Q				
1+40	0.0991		0.98	Q				
1+45	0.1059		0.99	Q				
1+50	0.1127		1.00	Q				
1+55	0.1196		1.00	VQ				
2+ 0	0.1266		1.01	IQ				
2+ 5	0.1336		1.02	IQ				
2+10	0.1406		1.02	IQ				
2+15	0.1477		1.03	IQ				
2+20	0.1548		1.03	IQ				
2+25	0.1620		1.04	IQ				
2+30	0.1692		1.04	IQ				
2+35	0.1764		1.05	IQ				
2+40	0.1836		1.05	IQ				
2+45	0.1909		1.06	IQ				
2+50	0.1982		1.06	IQ				
2+55	0.2055		1.06	IQ				
3+ 0	0.2129		1.07	IQ				
3+ 5	0.2203		1.07	IQ				
3+10	0.2277		1.08	IQ				
3+15	0.2351		1.08	IQ				

3+20	0.2426	1.08	Q				
3+25	0.2501	1.09	Q				
3+30	0.2576	1.09	QV				
3+35	0.2651	1.10	QV				
3+40	0.2727	1.10	QV				
3+45	0.2803	1.11	QV				
3+50	0.2880	1.11	QV				
3+55	0.2957	1.11	QV				
4+ 0	0.3034	1.12	QV				
4+ 5	0.3111	1.12	QV				
4+10	0.3189	1.13	QV				
4+15	0.3267	1.13	QV				
4+20	0.3345	1.14	QV				
4+25	0.3424	1.14	QV				
4+30	0.3503	1.15	QV				
4+35	0.3582	1.15	QV				
4+40	0.3662	1.16	QV				
4+45	0.3742	1.16	QV				
4+50	0.3822	1.17	Q V				
4+55	0.3903	1.17	Q V				
5+ 0	0.3984	1.18	Q V				
5+ 5	0.4066	1.18	Q V				
5+10	0.4147	1.19	Q V				
5+15	0.4230	1.19	Q V				
5+20	0.4312	1.20	Q V				
5+25	0.4395	1.20	Q V				
5+30	0.4478	1.21	Q V				
5+35	0.4562	1.22	Q V				
5+40	0.4646	1.22	Q V				
5+45	0.4731	1.23	Q V				
5+50	0.4816	1.23	Q V				
5+55	0.4901	1.24	Q V				
6+ 0	0.4987	1.24	Q V				
6+ 5	0.5073	1.25	Q V				
6+10	0.5160	1.26	Q V				
6+15	0.5247	1.26	Q V				
6+20	0.5334	1.27	Q V				
6+25	0.5422	1.28	Q V				
6+30	0.5510	1.28	Q V				
6+35	0.5599	1.29	Q V				
6+40	0.5688	1.30	Q V				
6+45	0.5778	1.30	Q V				
6+50	0.5868	1.31	Q V				
6+55	0.5959	1.32	Q V				
7+ 0	0.6050	1.32	Q V				
7+ 5	0.6142	1.33	Q V				
7+10	0.6234	1.34	Q V				
7+15	0.6326	1.35	Q V				
7+20	0.6420	1.35	Q V				
7+25	0.6513	1.36	Q V				
7+30	0.6608	1.37	Q V				
7+35	0.6702	1.38	Q V				
7+40	0.6798	1.38	Q V				
7+45	0.6893	1.39	Q V				
7+50	0.6990	1.40	Q V				
7+55	0.7087	1.41	Q V				
8+ 0	0.7184	1.42	Q V				
8+ 5	0.7283	1.43	Q V				
8+10	0.7381	1.43	Q V				
8+15	0.7481	1.44	Q V				
8+20	0.7581	1.45	Q V				
8+25	0.7681	1.46	Q V				
8+30	0.7783	1.47	Q V				

8+35	0.7885	1.48	Q	V				
8+40	0.7987	1.49	Q	V				
8+45	0.8090	1.50	Q	V				
8+50	0.8194	1.51	Q	V				
8+55	0.8299	1.52	Q	V				
9+ 0	0.8404	1.53	Q	V				
9+ 5	0.8510	1.54	Q	V				
9+10	0.8617	1.55	Q	V				
9+15	0.8725	1.56	Q	V				
9+20	0.8833	1.57	Q	V				
9+25	0.8942	1.58	Q	V				
9+30	0.9052	1.60	Q	V				
9+35	0.9163	1.61	Q	V				
9+40	0.9274	1.62	Q	V				
9+45	0.9387	1.63	Q	V				
9+50	0.9500	1.64	Q	V				
9+55	0.9614	1.66	Q	V				
10+ 0	0.9729	1.67	Q	V				
10+ 5	0.9845	1.68	Q	V				
10+10	0.9962	1.70	Q	V				
10+15	1.0080	1.71	Q	V				
10+20	1.0198	1.72	Q	V				
10+25	1.0318	1.74	Q	V				
10+30	1.0439	1.75	Q	V				
10+35	1.0561	1.77	Q	V				
10+40	1.0684	1.78	Q	V				
10+45	1.0808	1.80	Q	V				
10+50	1.0933	1.82	Q	V				
10+55	1.1059	1.83	Q	V				
11+ 0	1.1186	1.85	Q	V				
11+ 5	1.1315	1.87	Q	V				
11+10	1.1445	1.89	Q	V				
11+15	1.1576	1.90	Q	V				
11+20	1.1708	1.92	Q	V				
11+25	1.1842	1.94	Q	V				
11+30	1.1977	1.96	Q	V				
11+35	1.2114	1.98	Q	V				
11+40	1.2251	2.00	Q	V				
11+45	1.2391	2.02	Q	V				
11+50	1.2532	2.05	Q	V				
11+55	1.2674	2.07	Q	V				
12+ 0	1.2818	2.09	Q	V				
12+ 5	1.2964	2.11	Q	V				
12+10	1.3110	2.12	Q	V				
12+15	1.3256	2.11	Q	V				
12+20	1.3399	2.09	Q	V				
12+25	1.3542	2.08	Q	V				
12+30	1.3686	2.09	Q	V				
12+35	1.3831	2.10	Q	V				
12+40	1.3977	2.12	Q	V				
12+45	1.4124	2.14	Q	V				
12+50	1.4274	2.17	Q	V				
12+55	1.4425	2.19	Q	V				
13+ 0	1.4578	2.22	Q	V				
13+ 5	1.4733	2.25	Q	V				
13+10	1.4890	2.29	Q	V				
13+15	1.5050	2.32	Q	V				
13+20	1.5213	2.36	Q	V				
13+25	1.5378	2.40	Q	V				
13+30	1.5546	2.44	Q	V				
13+35	1.5718	2.49	Q	V				
13+40	1.5892	2.53	Q	V				
13+45	1.6070	2.58	Q	V				

13+50	1.6251	2.64	Q		V					
13+55	1.6437	2.69	Q		V					
14+ 0	1.6626	2.75	Q		V					
14+ 5	1.6820	2.81	Q		V					
14+10	1.7018	2.88	Q		V					
14+15	1.7221	2.95	Q		V					
14+20	1.7429	3.02	Q		V					
14+25	1.7643	3.11	Q		V					
14+30	1.7863	3.19	Q		V					
14+35	1.8089	3.29	Q		V					
14+40	1.8322	3.39	Q		V					
14+45	1.8563	3.49	Q		V					
14+50	1.8812	3.61	Q		V					
14+55	1.9069	3.74	Q		V					
15+ 0	1.9337	3.88	Q		V					
15+ 5	1.9615	4.04	Q		V					
15+10	1.9906	4.22	Q		V					
15+15	2.0210	4.41	Q		V					
15+20	2.0529	4.63	Q		V					
15+25	2.0864	4.87	Q		V					
15+30	2.1217	5.12	Q		V					
15+35	2.1583	5.32	Q		V					
15+40	2.1964	5.53	Q		V					
15+45	2.2370	5.91	Q		V					
15+50	2.2816	6.48	Q		V					
15+55	2.3321	7.33	Q		V					
16+ 0	2.3923	8.74	Q		V					
16+ 5	2.4777	12.39	Q	Q	V					
16+10	2.6122	19.54			QV					
16+15	2.8254	30.95				V		Q		
16+20	3.0735	36.03					V		Q	
16+25	3.2529	26.04					VQ			
16+30	3.3834	18.95			Q		V			
16+35	3.4890	15.34			Q		V			
16+40	3.5781	12.94			Q		V			
16+45	3.6546	11.11			Q		V			
16+50	3.7219	9.77			Q		V			
16+55	3.7823	8.77			Q		V			
17+ 0	3.8359	7.77			Q		V			
17+ 5	3.8836	6.93			Q		V			
17+10	3.9275	6.38			Q		V			
17+15	3.9680	5.87			Q		V			
17+20	4.0049	5.36			Q		V			
17+25	4.0391	4.97			Q		V			
17+30	4.0707	4.58			Q		V			
17+35	4.1001	4.28			Q		V			
17+40	4.1271	3.92			Q		V			
17+45	4.1523	3.66			Q		V			
17+50	4.1753	3.34			Q		V			
17+55	4.1974	3.20			Q		V			
18+ 0	4.2189	3.12			Q		V			
18+ 5	4.2397	3.02			Q		V			
18+10	4.2598	2.92			Q		V			
18+15	4.2789	2.78			Q		V			
18+20	4.2971	2.64			Q		V			
18+25	4.3147	2.56			Q		V			
18+30	4.3314	2.42			Q		V			
18+35	4.3468	2.25			Q		V			
18+40	4.3619	2.18			Q		V			
18+45	4.3766	2.13			Q		V			
18+50	4.3909	2.08			Q		V			
18+55	4.4049	2.04			Q		V			
19+ 0	4.4187	1.99	Q							V

19+ 5	4.4321	1.95	Q				V	
19+10	4.4453	1.92	Q				V	
19+15	4.4583	1.88	Q				V	
19+20	4.4710	1.84	Q				V	
19+25	4.4834	1.81	Q				V	
19+30	4.4957	1.78	Q				V	
19+35	4.5078	1.75	Q				V	
19+40	4.5196	1.72	Q				V	
19+45	4.5313	1.69	Q				V	
19+50	4.5428	1.67	Q				V	
19+55	4.5541	1.64	Q				V	
20+ 0	4.5652	1.62	Q				V	
20+ 5	4.5762	1.59	Q				V	
20+10	4.5870	1.57	Q				V	
20+15	4.5977	1.55	Q				V	
20+20	4.6082	1.53	Q				V	
20+25	4.6186	1.51	Q				V	
20+30	4.6288	1.49	Q				V	
20+35	4.6390	1.47	Q				V	
20+40	4.6490	1.45	Q				V	
20+45	4.6588	1.43	Q				V	
20+50	4.6686	1.42	Q				V	
20+55	4.6782	1.40	Q				V	
21+ 0	4.6877	1.38	Q				V	
21+ 5	4.6971	1.37	Q				V	
21+10	4.7064	1.35	Q				V	
21+15	4.7156	1.34	Q				V	
21+20	4.7247	1.32	Q				V	
21+25	4.7338	1.31	Q				V	
21+30	4.7427	1.29	Q				V	
21+35	4.7515	1.28	Q				V	
21+40	4.7602	1.27	Q				V	
21+45	4.7689	1.26	Q				V	
21+50	4.7774	1.24	Q				V	
21+55	4.7859	1.23	Q				V	
22+ 0	4.7943	1.22	Q				V	
22+ 5	4.8026	1.21	Q				V	
22+10	4.8109	1.20	Q				V	
22+15	4.8190	1.19	Q				V	
22+20	4.8271	1.18	Q				V	
22+25	4.8351	1.17	Q				V	
22+30	4.8431	1.16	Q				V	
22+35	4.8510	1.15	Q				V	
22+40	4.8588	1.14	Q				V	
22+45	4.8666	1.13	Q				V	
22+50	4.8743	1.12	Q				V	
22+55	4.8819	1.11	Q				V	
23+ 0	4.8895	1.10	Q				V	
23+ 5	4.8970	1.09	Q				V	
23+10	4.9044	1.08	Q				V	
23+15	4.9118	1.07	Q				V	
23+20	4.9191	1.07	Q				V	
23+25	4.9264	1.06	Q				V	
23+30	4.9337	1.05	Q				V	
23+35	4.9408	1.04	Q				V	
23+40	4.9480	1.03	Q				V	
23+45	4.9550	1.03	Q				V	
23+50	4.9621	1.02	Q				V	
23+55	4.9690	1.01	Q				V	
24+ 0	4.9760	1.01	Q				V	
24+ 5	4.9827	0.98	Q				V	
24+10	4.9891	0.92	Q				V	
24+15	4.9943	0.76	Q				V	

24+20	4.9980	0.54	Q				V
24+25	5.0008	0.41	Q				V
24+30	5.0031	0.32	Q				V
24+35	5.0049	0.26	Q				V
24+40	5.0064	0.22	Q				V
24+45	5.0076	0.18	Q				V
24+50	5.0087	0.15	Q				V
24+55	5.0096	0.13	Q				V
25+ 0	5.0103	0.11	Q				V
25+ 5	5.0110	0.09	Q				V
25+10	5.0115	0.08	Q				V
25+15	5.0120	0.07	Q				V
25+20	5.0123	0.06	Q				V
25+25	5.0127	0.05	Q				V
25+30	5.0129	0.04	Q				V
25+35	5.0131	0.03	Q				V
25+40	5.0133	0.03	Q				V
25+45	5.0135	0.02	Q				V
25+50	5.0136	0.02	Q				V
25+55	5.0137	0.02	Q				V
26+ 0	5.0138	0.01	Q				V
26+ 5	5.0139	0.01	Q				V
26+10	5.0139	0.01	Q				V
26+15	5.0140	0.00	Q				V
26+20	5.0140	0.00	Q				V
26+25	5.0140	0.00	Q				V

Unit Hydrograph Analysis
Copyright (c) CIVILCADD/CIVILDESIGN, 1989 - 2018, Version 9.0

Study date 08/31/23

+++++

San Bernardino County Synthetic Unit Hydrology Method
Manual date - August 1986

Program License Serial Number 6434

PRE-DEVELOPED D2 30 ACRE
100-Year 24-hour
AMC II

Storm Event Year = 100

Antecedent Moisture Condition = 2

English (in-lb) Input Units Used

English Rainfall Data (Inches) Input Values Used

English Units used in output format

Area averaged rainfall intensity isohyetal data:

Sub-Area (Ac.)	Duration (hours)	Isohyetal (In)
Rainfall data for year 100		
26.33	1	1.08

Rainfall data for year 100		
26.33	6	2.01

Rainfall data for year 100		
26.33	24	3.44

***** Area-averaged max loss rate, Fm *****

SCS curve No. (AMCII)	SCS curve NO. (AMC 2)	Area (Ac.)	Area Fraction	Fp (Fig C6) (In/Hr)	Ap (dec.)	Fm (In/Hr)
86.0	86.0	26.33	1.000	0.265	1.000	0.265

Area-averaged adjusted loss rate Fm (In/Hr) = 0.265

***** Area-Averaged low loss rate fraction, Yb *****

Area (Ac.)	Area Fract	SCS CN (AMC2)	SCS CN (AMC2)	S	Pervious Yield Fr
26.33	1.000	86.0	86.0	1.63	0.595

Area-averaged catchment yield fraction, Y = 0.595
 Area-averaged low loss fraction, Yb = 0.405
 User entry of time of concentration = 0.452 (hours)
 +++++
 Watershed area = 26.33(Ac.)
 Catchment Lag time = 0.361 hours
 Unit interval = 5.000 minutes
 Unit interval percentage of lag time = 23.0542
 Hydrograph baseflow = 0.00 (CFS)
 Average maximum watershed loss rate(Fm) = 0.265(In/Hr)
 Average low loss rate fraction (Yb) = 0.405 (decimal)
 DESERT S-Graph Selected
 Computed peak 5-minute rainfall = 0.512(In)
 Computed peak 30-minute rainfall = 0.877(In)
 Specified peak 1-hour rainfall = 1.080(In)
 Computed peak 3-hour rainfall = 1.581(In)
 Specified peak 6-hour rainfall = 2.010(In)
 Specified peak 24-hour rainfall = 3.440(In)

Rainfall depth area reduction factors:
 Using a total area of 26.33(Ac.) (Ref: fig. E-4)

5-minute factor = 0.999	Adjusted rainfall = 0.512(In)
30-minute factor = 0.999	Adjusted rainfall = 0.876(In)
1-hour factor = 0.999	Adjusted rainfall = 1.079(In)
3-hour factor = 1.000	Adjusted rainfall = 1.580(In)
6-hour factor = 1.000	Adjusted rainfall = 2.010(In)
24-hour factor = 1.000	Adjusted rainfall = 3.440(In)

U n i t H y d r o g r a p h

+++++

Interval Number	'S' Graph Mean values	Unit Hydrograph (CFS)
(K = 318.43 (CFS))		
1	1.208	3.846
2	5.724	14.382
3	15.856	32.264
4	35.942	63.959
5	51.767	50.390
6	61.713	31.671
7	68.394	21.275
8	73.534	16.368
9	77.576	12.871
10	80.794	10.247
11	83.440	8.426
12	85.751	7.358
13	87.754	6.379
14	89.374	5.157
15	90.720	4.285
16	91.949	3.916
17	93.034	3.454
18	94.003	3.086
19	94.801	2.541
20	95.564	2.428
21	96.188	1.988

22	96.778	1.880
23	97.237	1.460
24	97.650	1.315
25	97.948	0.950
26	98.179	0.734
27	98.431	0.804
28	98.708	0.881
29	98.985	0.881
30	99.261	0.881
31	99.511	0.795
32	99.664	0.487
33	99.808	0.459
34	100.000	0.229

Total soil rain loss = 1.17(In)
Total effective rainfall = 2.27(In)
Peak flow rate in flood hydrograph = 42.34(CFS)

+++++

24 - H O U R S T O R M
R u n o f f H y d r o g r a p h

Hydrograph in 5 Minute intervals ((CFS))

Time(h+m)	Volume Ac.Ft	Q(CFS)	0	12.5	25.0	37.5	50.0
0+ 5	0.0001	0.01	Q				
0+10	0.0004	0.05	Q				
0+15	0.0014	0.14	Q				
0+20	0.0036	0.32	Q				
0+25	0.0067	0.46	Q				
0+30	0.0104	0.54	Q				
0+35	0.0146	0.60	Q				
0+40	0.0191	0.65	Q				
0+45	0.0238	0.69	Q				
0+50	0.0288	0.72	Q				
0+55	0.0339	0.75	Q				
1+ 0	0.0392	0.77	Q				
1+ 5	0.0447	0.79	Q				
1+10	0.0502	0.81	Q				
1+15	0.0558	0.82	Q				
1+20	0.0616	0.83	Q				
1+25	0.0674	0.85	Q				
1+30	0.0733	0.86	Q				
1+35	0.0793	0.87	Q				
1+40	0.0853	0.88	Q				
1+45	0.0914	0.88	Q				
1+50	0.0976	0.89	Q				
1+55	0.1038	0.90	Q				
2+ 0	0.1100	0.91	Q				
2+ 5	0.1163	0.91	Q				
2+10	0.1226	0.92	Q				
2+15	0.1290	0.92	QV				
2+20	0.1354	0.93	QV				
2+25	0.1418	0.94	QV				
2+30	0.1483	0.94	QV				
2+35	0.1548	0.95	QV				
2+40	0.1614	0.95	QV				
2+45	0.1680	0.96	QV				
2+50	0.1746	0.96	QV				

2+55	0.1812	0.96	QV				
3+ 0	0.1879	0.97	QV				
3+ 5	0.1946	0.97	QV				
3+10	0.2013	0.97	QV				
3+15	0.2080	0.98	QV				
3+20	0.2148	0.98	QV				
3+25	0.2216	0.99	QV				
3+30	0.2284	0.99	QV				
3+35	0.2352	0.99	QV				
3+40	0.2421	1.00	QV				
3+45	0.2490	1.00	Q V				
3+50	0.2559	1.01	Q V				
3+55	0.2629	1.01	Q V				
4+ 0	0.2699	1.01	Q V				
4+ 5	0.2769	1.02	Q V				
4+10	0.2839	1.02	Q V				
4+15	0.2910	1.03	Q V				
4+20	0.2981	1.03	Q V				
4+25	0.3052	1.04	Q V				
4+30	0.3124	1.04	Q V				
4+35	0.3196	1.04	Q V				
4+40	0.3268	1.05	Q V				
4+45	0.3340	1.05	Q V				
4+50	0.3413	1.06	Q V				
4+55	0.3486	1.06	Q V				
5+ 0	0.3560	1.07	Q V				
5+ 5	0.3634	1.07	Q V				
5+10	0.3708	1.08	Q V				
5+15	0.3782	1.08	Q V				
5+20	0.3857	1.09	Q V				
5+25	0.3932	1.09	Q V				
5+30	0.4008	1.10	Q V				
5+35	0.4084	1.10	Q V				
5+40	0.4160	1.11	Q V				
5+45	0.4236	1.11	Q V				
5+50	0.4313	1.12	Q V				
5+55	0.4390	1.12	Q V				
6+ 0	0.4468	1.13	Q V				
6+ 5	0.4546	1.13	Q V				
6+10	0.4625	1.14	Q V				
6+15	0.4703	1.14	Q V				
6+20	0.4783	1.15	Q V				
6+25	0.4862	1.16	Q V				
6+30	0.4942	1.16	Q V				
6+35	0.5022	1.17	Q V				
6+40	0.5103	1.17	Q V				
6+45	0.5185	1.18	Q V				
6+50	0.5266	1.19	Q V				
6+55	0.5348	1.19	Q V				
7+ 0	0.5431	1.20	Q V				
7+ 5	0.5514	1.20	Q V				
7+10	0.5597	1.21	Q V				
7+15	0.5681	1.22	Q V				
7+20	0.5765	1.22	Q V				
7+25	0.5850	1.23	Q V				
7+30	0.5935	1.24	Q V				
7+35	0.6021	1.25	Q V				
7+40	0.6107	1.25	IQ V				
7+45	0.6194	1.26	IQ V				
7+50	0.6281	1.27	IQ V				
7+55	0.6369	1.27	IQ V				
8+ 0	0.6457	1.28	IQ V				
8+ 5	0.6546	1.29	IQ V				

8+10	0.6636	1.30	Q	V				
8+15	0.6726	1.31	Q	V				
8+20	0.6816	1.31	Q	V				
8+25	0.6907	1.32	Q	V				
8+30	0.6999	1.33	Q	V				
8+35	0.7091	1.34	Q	V				
8+40	0.7184	1.35	Q	V				
8+45	0.7277	1.36	Q	V				
8+50	0.7371	1.36	Q	V				
8+55	0.7466	1.37	Q	V				
9+ 0	0.7561	1.38	Q	V				
9+ 5	0.7657	1.39	Q	V				
9+10	0.7753	1.40	Q	V				
9+15	0.7851	1.41	Q	V				
9+20	0.7949	1.42	Q	V				
9+25	0.8047	1.43	Q	V				
9+30	0.8147	1.44	Q	V				
9+35	0.8247	1.45	Q	V				
9+40	0.8347	1.46	Q	V				
9+45	0.8449	1.47	Q	V				
9+50	0.8551	1.49	Q	V				
9+55	0.8654	1.50	Q	V				
10+ 0	0.8758	1.51	Q	V				
10+ 5	0.8863	1.52	Q	V				
10+10	0.8969	1.53	Q	V				
10+15	0.9075	1.55	Q	V				
10+20	0.9182	1.56	Q	V				
10+25	0.9290	1.57	Q	V				
10+30	0.9400	1.58	Q	V				
10+35	0.9510	1.60	Q	V				
10+40	0.9621	1.61	Q	V				
10+45	0.9732	1.63	Q	V				
10+50	0.9845	1.64	Q	V				
10+55	0.9959	1.65	Q	V				
11+ 0	1.0074	1.67	Q	V				
11+ 5	1.0190	1.69	Q	V				
11+10	1.0308	1.70	Q	V				
11+15	1.0426	1.72	Q	V				
11+20	1.0545	1.73	Q	V				
11+25	1.0666	1.75	Q	V				
11+30	1.0788	1.77	Q	V				
11+35	1.0911	1.79	Q	V				
11+40	1.1035	1.81	Q	V				
11+45	1.1161	1.82	Q	V				
11+50	1.1288	1.84	Q	V				
11+55	1.1416	1.86	Q	V				
12+ 0	1.1546	1.89	Q	V				
12+ 5	1.1678	1.90	Q	V				
12+10	1.1810	1.92	Q	V				
12+15	1.1942	1.92	Q	V				
12+20	1.2072	1.90	Q	V				
12+25	1.2202	1.89	Q	V				
12+30	1.2333	1.89	Q	V				
12+35	1.2464	1.90	Q	V				
12+40	1.2596	1.92	Q	V				
12+45	1.2729	1.93	Q	V				
12+50	1.2864	1.96	Q	V				
12+55	1.3000	1.98	Q	V				
13+ 0	1.3138	2.00	Q	V				
13+ 5	1.3278	2.03	Q	V				
13+10	1.3420	2.06	Q	V				
13+15	1.3564	2.09	Q	V				
13+20	1.3710	2.12	Q	V				

13+25	1.3859	2.16	Q	V				
13+30	1.4010	2.20	Q	V				
13+35	1.4164	2.23	Q	V				
13+40	1.4320	2.27	Q	V				
13+45	1.4480	2.32	Q	V				
13+50	1.4643	2.36	Q	V				
13+55	1.4809	2.41	Q	V				
14+ 0	1.4978	2.46	Q	V				
14+ 5	1.5152	2.52	Q	V				
14+10	1.5329	2.57	Q	V				
14+15	1.5510	2.64	Q	V				
14+20	1.5697	2.70	Q	V				
14+25	1.5888	2.77	Q	V				
14+30	1.6084	2.85	Q	V				
14+35	1.6286	2.93	Q	V				
14+40	1.6494	3.02	Q	V				
14+45	1.6708	3.11	Q	V				
14+50	1.6929	3.21	Q	V				
14+55	1.7158	3.32	Q	V				
15+ 0	1.7395	3.45	Q	V				
15+ 5	1.7642	3.58	Q	V				
15+10	1.7899	3.73	Q	V				
15+15	1.8167	3.90	Q	V				
15+20	1.8449	4.09	Q	V				
15+25	1.8744	4.29	Q	V				
15+30	1.9055	4.50	Q	V				
15+35	1.9379	4.70	Q	V				
15+40	1.9715	4.89	Q	V				
15+45	2.0071	5.16	Q	V				
15+50	2.0457	5.61	Q	V				
15+55	2.0891	6.30	Q	V				
16+ 0	2.1412	7.57	Q	V				
16+ 5	2.2185	11.21	Q	V				
16+10	2.3466	18.61	Q	V				
16+15	2.5456	28.90	Q	V				
16+20	2.8372	42.34	Q	V				
16+25	3.0772	34.85	Q	V				
16+30	3.2482	24.83	Q	V				
16+35	3.3778	18.81	Q	V				
16+40	3.4853	15.61	Q	V				
16+45	3.5765	13.23	Q	V				
16+50	3.6549	11.38	Q	V				
16+55	3.7237	10.00	Q	V				
17+ 0	3.7859	9.03	Q	V				
17+ 5	3.8419	8.13	Q	V				
17+10	3.8915	7.20	Q	V				
17+15	3.9362	6.49	Q	V				
17+20	3.9777	6.03	Q	V				
17+25	4.0160	5.56	Q	V				
17+30	4.0515	5.16	Q	V				
17+35	4.0839	4.70	Q	V				
17+40	4.1146	4.45	Q	V				
17+45	4.1427	4.08	Q	V				
17+50	4.1692	3.85	Q	V				
17+55	4.1934	3.51	Q	V				
18+ 0	4.2161	3.30	Q	V				
18+ 5	4.2368	3.01	Q	V				
18+10	4.2563	2.83	Q	V				
18+15	4.2756	2.80	Q	V				
18+20	4.2948	2.79	Q	V				
18+25	4.3137	2.75	Q	V				
18+30	4.3322	2.68	Q	V				
18+35	4.3498	2.56	Q	V				

18+40	4.3660	2.35	Q				V	
18+45	4.3815	2.25	Q				V	
18+50	4.3959	2.08	Q				V	
18+55	4.4091	1.92	Q				V	
19+ 0	4.4219	1.87	Q				V	
19+ 5	4.4345	1.83	Q				V	
19+10	4.4468	1.79	Q				V	
19+15	4.4589	1.75	Q				V	
19+20	4.4707	1.71	Q				V	
19+25	4.4822	1.68	Q				V	
19+30	4.4936	1.65	Q				V	
19+35	4.5048	1.62	Q				V	
19+40	4.5157	1.59	Q				V	
19+45	4.5265	1.57	Q				V	
19+50	4.5372	1.54	Q				V	
19+55	4.5476	1.52	Q				V	
20+ 0	4.5579	1.49	Q				V	
20+ 5	4.5680	1.47	Q				V	
20+10	4.5780	1.45	Q				V	
20+15	4.5878	1.43	Q				V	
20+20	4.5975	1.41	Q				V	
20+25	4.6071	1.39	Q				V	
20+30	4.6166	1.37	Q				V	
20+35	4.6259	1.35	Q				V	
20+40	4.6351	1.34	Q				V	
20+45	4.6442	1.32	Q				V	
20+50	4.6531	1.30	Q				V	
20+55	4.6620	1.29	Q				V	
21+ 0	4.6708	1.27	Q				V	
21+ 5	4.6794	1.26	Q				V	
21+10	4.6880	1.24	Q				V	
21+15	4.6964	1.23	Q				V	
21+20	4.7048	1.21	Q				V	
21+25	4.7131	1.20	Q				V	
21+30	4.7213	1.19	Q				V	
21+35	4.7294	1.18	Q				V	
21+40	4.7374	1.16	Q				V	
21+45	4.7453	1.15	Q				V	
21+50	4.7532	1.14	Q				V	
21+55	4.7610	1.13	Q				V	
22+ 0	4.7687	1.12	Q				V	
22+ 5	4.7763	1.11	Q				V	
22+10	4.7839	1.10	Q				V	
22+15	4.7914	1.09	Q				V	
22+20	4.7988	1.08	Q				V	
22+25	4.8062	1.07	Q				V	
22+30	4.8134	1.06	Q				V	
22+35	4.8207	1.05	Q				V	
22+40	4.8278	1.04	Q				V	
22+45	4.8350	1.03	Q				V	
22+50	4.8420	1.02	Q				V	
22+55	4.8490	1.02	Q				V	
23+ 0	4.8559	1.01	Q				V	
23+ 5	4.8628	1.00	Q				V	
23+10	4.8696	0.99	Q				V	
23+15	4.8764	0.98	Q				V	
23+20	4.8831	0.98	Q				V	
23+25	4.8898	0.97	Q				V	
23+30	4.8964	0.96	Q				V	
23+35	4.9030	0.95	Q				V	
23+40	4.9095	0.95	Q				V	
23+45	4.9160	0.94	Q				V	
23+50	4.9224	0.93	Q				V	

23+55	4.9288	0.93	Q				V
24+ 0	4.9351	0.92	Q				V
24+ 5	4.9414	0.90	Q				V
24+10	4.9473	0.86	Q				V
24+15	4.9525	0.76	Q				V
24+20	4.9565	0.58	Q				V
24+25	4.9596	0.44	Q				V
24+30	4.9620	0.35	Q				V
24+35	4.9640	0.29	Q				V
24+40	4.9656	0.24	Q				V
24+45	4.9671	0.20	Q				V
24+50	4.9683	0.18	Q				V
24+55	4.9693	0.15	Q				V
25+ 0	4.9702	0.13	Q				V
25+ 5	4.9710	0.11	Q				V
25+10	4.9716	0.10	Q				V
25+15	4.9722	0.08	Q				V
25+20	4.9727	0.07	Q				V
25+25	4.9731	0.06	Q				V
25+30	4.9735	0.05	Q				V
25+35	4.9738	0.05	Q				V
25+40	4.9741	0.04	Q				V
25+45	4.9743	0.03	Q				V
25+50	4.9745	0.03	Q				V
25+55	4.9747	0.02	Q				V
26+ 0	4.9748	0.02	Q				V
26+ 5	4.9749	0.02	Q				V
26+10	4.9750	0.02	Q				V
26+15	4.9751	0.01	Q				V
26+20	4.9752	0.01	Q				V
26+25	4.9753	0.01	Q				V
26+30	4.9753	0.01	Q				V
26+35	4.9753	0.00	Q				V
26+40	4.9753	0.00	Q				V
26+45	4.9753	0.00	Q				V

Unit Hydrograph Analysis
 Copyright (c) CIVILCADD/CIVILDESIGN, 1989 - 2018, Version 9.0

Study date 08/31/23

+++++

San Bernardino County Synthetic Unit Hydrology Method
 Manual date - August 1986

Program License Serial Number 6434

**PRE-DEVELOPED D2 30 ACRE
 100-Year 24-hour
 AMC III**

Storm Event Year = 100

Antecedent Moisture Condition = 3

English (in-lb) Input Units Used

English Rainfall Data (Inches) Input Values Used

English Units used in output format.

Area averaged rainfall intensity isohyetal data:

Sub-Area (Ac.)	Duration (hours)	Isohyetal (In)
Rainfall data for year 100		
26.33	1	1.08

Rainfall data for year 100		
26.33	6	2.01

Rainfall data for year 100		
26.33	24	3.44

+++++

***** Area-averaged max loss rate, Fm *****

SCS curve No. (AMCII)	SCS curve NO. (AMC 3)	Area (Ac.)	Area Fraction	Fp (Fig C6) (In/Hr)	Ap (dec.)	Fm (In/Hr)
86.0	97.2	26.33	1.000	0.055	1.000	0.055

Area-averaged adjusted loss rate Fm (In/Hr) = 0.055

***** Area-Averaged low loss rate fraction, Yb *****

Area (Ac.)	Area Fract	SCS CN (AMC2)	SCS CN (AMC3)	S	Pervious Yield Fr
26.33	1.000	86.0	97.2	0.29	0.906

Area-averaged catchment yield fraction, Y = 0.906
 Area-averaged low loss fraction, Yb = 0.094
 User entry of time of concentration = 0.447 (hours)
 ++++++
 Watershed area = 26.33 (Ac.)
 Catchment Lag time = 0.358 hours
 Unit interval = 5.000 minutes
 Unit interval percentage of lag time = 23.3035
 Hydrograph baseflow = 0.00 (CFS)
 Average maximum watershed loss rate (Fm) = 0.055 (In/Hr)
 Average low loss rate fraction (Yb) = 0.094 (decimal)
 DESERT S-Graph Selected
 Computed peak 5-minute rainfall = 0.512 (In)
 Computed peak 30-minute rainfall = 0.877 (In)
 Specified peak 1-hour rainfall = 1.080 (In)
 Computed peak 3-hour rainfall = 1.581 (In)
 Specified peak 6-hour rainfall = 2.010 (In)
 Specified peak 24-hour rainfall = 3.440 (In)

Rainfall depth area reduction factors:
 Using a total area of 26.33 (Ac.) (Ref: fig. E-4)

5-minute factor = 0.999	Adjusted rainfall = 0.512 (In)
30-minute factor = 0.999	Adjusted rainfall = 0.876 (In)
1-hour factor = 0.999	Adjusted rainfall = 1.079 (In)
3-hour factor = 1.000	Adjusted rainfall = 1.580 (In)
6-hour factor = 1.000	Adjusted rainfall = 2.010 (In)
24-hour factor = 1.000	Adjusted rainfall = 3.440 (In)

U n i t H y d r o g r a p h

+++++

Interval Number	'S' Graph Mean values	Unit Hydrograph (CFS)
(K = 318.43 (CFS))		
1	1.226	3.903
2	5.830	14.663
3	16.313	33.380
4	36.673	64.830
5	52.365	49.968
6	62.172	31.230
7	68.800	21.104
8	73.888	16.202
9	77.904	12.788
10	81.089	10.143
11	83.716	8.363
12	86.020	7.336
13	88.000	6.305
14	89.576	5.018
15	90.922	4.288
16	92.138	3.870
17	93.218	3.440
18	94.162	3.007
19	94.958	2.533
20	95.706	2.382
21	96.321	1.958

259	0.0058	0.0005	0.0053
260	0.0058	0.0005	0.0052
261	0.0057	0.0005	0.0052
262	0.0057	0.0005	0.0051
263	0.0056	0.0005	0.0051
264	0.0056	0.0005	0.0050
265	0.0055	0.0005	0.0050
266	0.0055	0.0005	0.0050
267	0.0054	0.0005	0.0049
268	0.0054	0.0005	0.0049
269	0.0053	0.0005	0.0048
270	0.0053	0.0005	0.0048
271	0.0053	0.0005	0.0048
272	0.0052	0.0005	0.0047
273	0.0052	0.0005	0.0047
274	0.0051	0.0005	0.0046
275	0.0051	0.0005	0.0046
276	0.0051	0.0005	0.0046
277	0.0050	0.0005	0.0045
278	0.0050	0.0005	0.0045
279	0.0049	0.0005	0.0045
280	0.0049	0.0005	0.0045
281	0.0049	0.0005	0.0044
282	0.0048	0.0005	0.0044
283	0.0048	0.0005	0.0044
284	0.0048	0.0004	0.0043
285	0.0047	0.0004	0.0043
286	0.0047	0.0004	0.0043
287	0.0047	0.0004	0.0042
288	0.0047	0.0004	0.0042

Total soil rain loss = 0.27(In)
Total effective rainfall = 3.17(In)
Peak flow rate in flood hydrograph = 47.40(CFS)

+++++

24 - H O U R S T O R M
R u n o f f H y d r o g r a p h

Hydrograph in 5 Minute intervals ((CFS))

Time(h+m)	Volume	Ac.Ft	Q(CFS)	0	12.5	25.0	37.5	50.0
0+ 5	0.0001	0.02	Q					
0+10	0.0007	0.08	Q					
0+15	0.0022	0.22	Q					
0+20	0.0055	0.49	Q					
0+25	0.0104	0.70	Q					
0+30	0.0161	0.84	Q					
0+35	0.0225	0.93	Q					
0+40	0.0294	1.00	Q					
0+45	0.0367	1.06	Q					
0+50	0.0442	1.10	Q					
0+55	0.0521	1.14	Q					
1+ 0	0.0602	1.17	Q					
1+ 5	0.0685	1.20	Q					
1+10	0.0769	1.23	Q					
1+15	0.0856	1.25	VQ					
1+20	0.0943	1.27	VQ					
1+25	0.1032	1.29	VQ					
1+30	0.1122	1.31	VQ					

1+35	0.1213	1.32	VQ				
1+40	0.1306	1.34	VQ				
1+45	0.1399	1.35	VQ				
1+50	0.1493	1.36	VQ				
1+55	0.1587	1.37	VQ				
2+ 0	0.1682	1.38	VQ				
2+ 5	0.1778	1.39	IQ				
2+10	0.1875	1.40	IQ				
2+15	0.1972	1.41	IQ				
2+20	0.2069	1.42	IQ				
2+25	0.2168	1.43	IQ				
2+30	0.2267	1.44	IQ				
2+35	0.2366	1.44	IQ				
2+40	0.2466	1.45	IQ				
2+45	0.2566	1.46	IQ				
2+50	0.2667	1.47	IQ				
2+55	0.2769	1.47	IQ				
3+ 0	0.2870	1.48	IQ				
3+ 5	0.2972	1.48	IQ				
3+10	0.3075	1.49	IQ				
3+15	0.3178	1.49	IQ				
3+20	0.3281	1.50	IQ				
3+25	0.3385	1.50	IQ				
3+30	0.3489	1.51	IQV				
3+35	0.3593	1.52	IQV				
3+40	0.3698	1.52	IQV				
3+45	0.3803	1.53	IQV				
3+50	0.3909	1.53	IQV				
3+55	0.4015	1.54	IQV				
4+ 0	0.4122	1.55	IQV				
4+ 5	0.4229	1.55	IQV				
4+10	0.4336	1.56	IQV				
4+15	0.4444	1.57	IQV				
4+20	0.4552	1.57	IQV				
4+25	0.4661	1.58	IQV				
4+30	0.4770	1.59	IQV				
4+35	0.4880	1.59	IQV				
4+40	0.4990	1.60	IQV				
4+45	0.5101	1.61	IQV				
4+50	0.5212	1.61	IQV				
4+55	0.5324	1.62	IQ V				
5+ 0	0.5436	1.63	IQ V				
5+ 5	0.5548	1.64	IQ V				
5+10	0.5661	1.64	IQ V				
5+15	0.5775	1.65	IQ V				
5+20	0.5889	1.66	IQ V				
5+25	0.6004	1.66	IQ V				
5+30	0.6119	1.67	IQ V				
5+35	0.6235	1.68	IQ V				
5+40	0.6351	1.69	IQ V				
5+45	0.6468	1.70	IQ V				
5+50	0.6585	1.70	IQ V				
5+55	0.6703	1.71	IQ V				
6+ 0	0.6822	1.72	IQ V				
6+ 5	0.6941	1.73	IQ V				
6+10	0.7060	1.74	IQ V				
6+15	0.7181	1.75	IQ V				
6+20	0.7301	1.75	IQ V				
6+25	0.7423	1.76	IQ V				
6+30	0.7545	1.77	IQ V				
6+35	0.7668	1.78	IQ V				
6+40	0.7791	1.79	IQ V				
6+45	0.7915	1.80	IQ V				

6+50	0.8040	1.81	Q	V					
6+55	0.8165	1.82	Q	V					
7+ 0	0.8291	1.83	Q	V					
7+ 5	0.8417	1.84	Q	V					
7+10	0.8545	1.85	Q	V					
7+15	0.8673	1.86	Q	V					
7+20	0.8801	1.87	Q	V					
7+25	0.8931	1.88	Q	V					
7+30	0.9061	1.89	Q	V					
7+35	0.9192	1.90	Q	V					
7+40	0.9323	1.91	Q	V					
7+45	0.9456	1.92	Q	V					
7+50	0.9589	1.93	Q	V					
7+55	0.9723	1.94	Q	V					
8+ 0	0.9858	1.96	Q	V					
8+ 5	0.9993	1.97	Q	V					
8+10	1.0129	1.98	Q	V					
8+15	1.0267	1.99	Q	V					
8+20	1.0405	2.00	Q	V					
8+25	1.0544	2.02	Q	V					
8+30	1.0683	2.03	Q	V					
8+35	1.0824	2.04	Q	V					
8+40	1.0966	2.06	Q	V					
8+45	1.1108	2.07	Q	V					
8+50	1.1252	2.08	Q	V					
8+55	1.1396	2.10	Q	V					
9+ 0	1.1542	2.11	Q	V					
9+ 5	1.1688	2.13	Q	V					
9+10	1.1835	2.14	Q	V					
9+15	1.1984	2.15	Q	V					
9+20	1.2133	2.17	Q	V					
9+25	1.2284	2.19	Q	V					
9+30	1.2435	2.20	Q	V					
9+35	1.2588	2.22	Q	V					
9+40	1.2742	2.23	Q	V					
9+45	1.2897	2.25	Q	V					
9+50	1.3053	2.27	Q	V					
9+55	1.3210	2.28	Q	V					
10+ 0	1.3369	2.30	Q	V					
10+ 5	1.3529	2.32	Q	V					
10+10	1.3690	2.34	Q	V					
10+15	1.3852	2.36	Q	V					
10+20	1.4016	2.38	Q	V					
10+25	1.4181	2.40	Q	V					
10+30	1.4348	2.42	Q	V					
10+35	1.4516	2.44	Q	V					
10+40	1.4685	2.46	Q	V					
10+45	1.4856	2.48	Q	V					
10+50	1.5028	2.50	Q	V					
10+55	1.5202	2.53	Q	V					
11+ 0	1.5378	2.55	Q	V					
11+ 5	1.5555	2.57	Q	V					
11+10	1.5734	2.60	Q	V					
11+15	1.5914	2.62	Q	V					
11+20	1.6096	2.65	Q	V					
11+25	1.6281	2.67	Q	V					
11+30	1.6467	2.70	Q	V					
11+35	1.6654	2.73	Q	V					
11+40	1.6844	2.76	Q	V					
11+45	1.7036	2.79	Q	V					
11+50	1.7230	2.82	Q	V					
11+55	1.7426	2.85	Q	V					
12+ 0	1.7624	2.88	Q	V					

12+ 5	1.7825	2.91	Q	V				
12+10	1.8026	2.93	Q	V				
12+15	1.8228	2.93	Q	V				
12+20	1.8427	2.90	Q	V				
12+25	1.8625	2.88	Q	V				
12+30	1.8824	2.89	Q	V				
12+35	1.9024	2.90	Q	V				
12+40	1.9225	2.93	Q	V				
12+45	1.9429	2.95	Q	V				
12+50	1.9634	2.99	Q	V				
12+55	1.9842	3.02	Q	V				
13+ 0	2.0053	3.06	Q	V				
13+ 5	2.0267	3.10	Q	V				
13+10	2.0483	3.15	Q	V				
13+15	2.0703	3.19	Q	V				
13+20	2.0926	3.24	Q	V				
13+25	2.1153	3.29	Q	V				
13+30	2.1384	3.35	Q	V				
13+35	2.1619	3.41	Q	V				
13+40	2.1858	3.47	Q	V				
13+45	2.2102	3.54	Q	V				
13+50	2.2350	3.61	Q	V				
13+55	2.2604	3.68	Q	V				
14+ 0	2.2863	3.76	Q	V				
14+ 5	2.3127	3.84	Q	V				
14+10	2.3398	3.93	Q	V				
14+15	2.3676	4.03	Q	V				
14+20	2.3960	4.13	Q	V				
14+25	2.4252	4.24	Q	V				
14+30	2.4551	4.35	Q	V				
14+35	2.4860	4.47	Q	V				
14+40	2.5177	4.61	Q	V				
14+45	2.5504	4.75	Q	V				
14+50	2.5842	4.91	Q	V				
14+55	2.6192	5.08	Q	V				
15+ 0	2.6555	5.27	Q	V				
15+ 5	2.6932	5.47	Q	V				
15+10	2.7325	5.70	Q	V				
15+15	2.7735	5.95	Q	V				
15+20	2.8165	6.25	Q	V				
15+25	2.8617	6.56	Q	V				
15+30	2.9091	6.88	Q	V				
15+35	2.9586	7.19	Q	V				
15+40	3.0100	7.47	Q	V				
15+45	3.0644	7.90	Q	V				
15+50	3.1235	8.59	Q	V				
15+55	3.1896	9.60	Q	V				
16+ 0	3.2674	11.29	Q	V				
16+ 5	3.3736	15.41	Q	V				
16+10	3.5338	23.26	Q	V				
16+15	3.7684	34.07	Q	V				
16+20	4.0949	47.40	Q	V				
16+25	4.3651	39.23	Q	V				
16+30	4.5641	28.89	Q	V				
16+35	4.7199	22.62	Q	V				
16+40	4.8515	19.11	Q	V				
16+45	4.9652	16.50	Q	V				
16+50	5.0643	14.39	Q	V				
16+55	5.1525	12.80	Q	V				
17+ 0	5.2326	11.64	Q	V				
17+ 5	5.3053	10.55	Q	V				
17+10	5.3703	9.44	Q	V				
17+15	5.4298	8.64	Q	V				

17+20	5.4852	8.04		Q				V	
17+25	5.5366	7.47		Q				V	
17+30	5.5844	6.94		Q				V	
17+35	5.6286	6.42		Q				V	
17+40	5.6704	6.06		Q				V	
17+45	5.7090	5.62		Q				V	
17+50	5.7456	5.31		Q				V	
17+55	5.7794	4.90		Q				V	
18+ 0	5.8113	4.63		Q				V	
18+ 5	5.8407	4.27		Q				V	
18+10	5.8689	4.10		Q				V	
18+15	5.8968	4.05		Q				V	
18+20	5.9244	4.01		Q				V	
18+25	5.9515	3.94		Q				V	
18+30	5.9780	3.84		Q				V	
18+35	6.0030	3.64		Q				V	
18+40	6.0268	3.44		Q				V	
18+45	6.0497	3.34		Q				V	
18+50	6.0719	3.22		Q				V	
18+55	6.0921	2.93		Q				V	
19+ 0	6.1118	2.85		Q				V	
19+ 5	6.1310	2.79		Q				V	
19+10	6.1497	2.73		Q				V	
19+15	6.1681	2.67		Q				V	
19+20	6.1861	2.61		Q				V	
19+25	6.2038	2.56		Q				V	
19+30	6.2211	2.52		Q				V	
19+35	6.2381	2.47		Q				V	
19+40	6.2549	2.43		Q				V	
19+45	6.2713	2.39		Q				V	
19+50	6.2875	2.35		Q				V	
19+55	6.3035	2.31		Q				V	
20+ 0	6.3192	2.28		Q				V	
20+ 5	6.3346	2.24		Q				V	
20+10	6.3498	2.21		Q				V	
20+15	6.3648	2.18		Q				V	
20+20	6.3796	2.15		Q				V	
20+25	6.3942	2.12		Q				V	
20+30	6.4086	2.09		Q				V	
20+35	6.4228	2.06		Q				V	
20+40	6.4369	2.04		Q				V	
20+45	6.4507	2.01		Q				V	
20+50	6.4644	1.99		Q				V	
20+55	6.4779	1.96		Q				V	
21+ 0	6.4913	1.94		Q				V	
21+ 5	6.5045	1.92		Q				V	
21+10	6.5176	1.90		Q				V	
21+15	6.5305	1.87		Q				V	
21+20	6.5432	1.85		Q				V	
21+25	6.5559	1.83		Q				V	
21+30	6.5683	1.81		Q				V	
21+35	6.5807	1.79		Q				V	
21+40	6.5929	1.78		Q				V	
21+45	6.6050	1.76		Q				V	
21+50	6.6170	1.74		Q				V	
21+55	6.6289	1.72		Q				V	
22+ 0	6.6407	1.71		Q				V	
22+ 5	6.6523	1.69		Q				V	
22+10	6.6638	1.67		Q				V	
22+15	6.6753	1.66		Q				V	
22+20	6.6866	1.64		Q				V	
22+25	6.6978	1.63		Q				V	
22+30	6.7089	1.62		Q				V	

22+35	6.7200	1.60	Q				V	
22+40	6.7309	1.59	Q				V	
22+45	6.7417	1.57	Q				V	
22+50	6.7525	1.56	Q				V	
22+55	6.7632	1.55	Q				V	
23+ 0	6.7737	1.54	Q				V	
23+ 5	6.7842	1.52	Q				V	
23+10	6.7946	1.51	Q				V	
23+15	6.8050	1.50	Q				V	
23+20	6.8152	1.49	Q				V	
23+25	6.8254	1.48	Q				V	
23+30	6.8355	1.47	Q				V	
23+35	6.8455	1.46	Q				V	
23+40	6.8555	1.44	Q				V	
23+45	6.8653	1.43	Q				V	
23+50	6.8752	1.42	Q				V	
23+55	6.8849	1.41	Q				V	
24+ 0	6.8946	1.40	Q				V	
24+ 5	6.9041	1.38	Q				V	
24+10	6.9131	1.31	Q				V	
24+15	6.9210	1.16	Q				V	
24+20	6.9271	0.88	Q				V	
24+25	6.9317	0.66	Q				V	
24+30	6.9353	0.53	Q				V	
24+35	6.9383	0.44	Q				V	
24+40	6.9408	0.37	Q				V	
24+45	6.9430	0.31	Q				V	
24+50	6.9448	0.26	Q				V	
24+55	6.9464	0.23	Q				V	
25+ 0	6.9477	0.20	Q				V	
25+ 5	6.9489	0.17	Q				V	
25+10	6.9499	0.15	Q				V	
25+15	6.9507	0.13	Q				V	
25+20	6.9515	0.11	Q				V	
25+25	6.9521	0.09	Q				V	
25+30	6.9527	0.08	Q				V	
25+35	6.9532	0.07	Q				V	
25+40	6.9536	0.06	Q				V	
25+45	6.9539	0.05	Q				V	
25+50	6.9542	0.04	Q				V	
25+55	6.9545	0.04	Q				V	
26+ 0	6.9547	0.03	Q				V	
26+ 5	6.9549	0.03	Q				V	
26+10	6.9551	0.02	Q				V	
26+15	6.9552	0.02	Q				V	
26+20	6.9553	0.02	Q				V	
26+25	6.9554	0.01	Q				V	
26+30	6.9555	0.01	Q				V	
26+35	6.9555	0.01	Q				V	
26+40	6.9555	0.00	Q				V	
26+45	6.9555	0.00	Q				V	

San Bernardino County Rational Hydrology Program

(Hydrology Manual Date - August 1986)

CIVILCADD/CIVILDESIGN Engineering Software, (c) 1989-2018 Version 9.0
Rational Hydrology Study Date: 06/23/23

100 YEAR 1 HOUR STORM
AMC III
DEVELOPED 30 AC DAI

Program License Serial Number 6434

***** Hydrology Study Control Information *****

Rational hydrology study storm event year is 100.0
Computed rainfall intensity:
Storm year = 100.00 1 hour rainfall = 1.080 (In.)
Slope used for rainfall intensity curve b = 0.7000
Soil antecedent moisture condition (AMC) = 3

+++++
Process from Point/Station 0.000 to Point/Station 1.000
**** INITIAL AREA EVALUATION ****

COMMERCIAL subarea type
Decimal fraction soil group A = 1.000
Decimal fraction soil group B = 0.000
Decimal fraction soil group C = 0.000
Decimal fraction soil group D = 0.000
SCS curve number for soil(AMC 2) = 32.00
Adjusted SCS curve number for AMC 3 = 52.00
Pervious ratio(Ap) = 0.1000 Max loss rate(Fm)= 0.079(In/Hr)
Initial subarea data:
Initial area flow distance = 101.720(Ft.)
Top (of initial area) elevation = 3167.000(Ft.)
Bottom (of initial area) elevation = 3158.000(Ft.)
Difference in elevation = 9.000(Ft.)
Slope = 0.08848 s(%)= 8.85
TC = k(0.304)*[(length^3)/(elevation change)]^0.2
Initial area time of concentration = 3.137 min.
Rainfall intensity = 8.523(In/Hr) for a 100.0 year storm
Effective runoff coefficient used for area (Q=KCIA) is C = 0.892
Subarea runoff = 2.128(CFS)
Total initial stream area = 0.280(Ac.)
Pervious area fraction = 0.100
Initial area Fm value = 0.079(In/Hr)

+++++
Process from Point/Station 1.000 to Point/Station 2.000
**** IMPROVED CHANNEL TRAVEL TIME ****

Upstream point elevation = 3158.000(Ft.)
Downstream point elevation = 3155.800(Ft.)
Channel length thru subarea = 320.800(Ft.)

Channel base width = 3.000(Ft.)
 Slope or 'Z' of left channel bank = 50.000
 Slope or 'Z' of right channel bank = 50.000
 Estimated mean flow rate at midpoint of channel = 8.002(CFS)
 Manning's 'N' = 0.015
 Maximum depth of channel = 1.000(Ft.)
 Flow(q) thru subarea = 8.002(CFS)
 Depth of flow = 0.244(Ft.), Average velocity = 2.161(Ft/s)
 Channel flow top width = 27.377(Ft.)
 Flow Velocity = 2.16(Ft/s)
 Travel time = 2.47 min.
 Time of concentration = 5.61 min.
 Critical depth = 0.248(Ft.)
 Adding area flow to channel
 COMMERCIAL subarea type
 Decimal fraction soil group A = 1.000
 Decimal fraction soil group B = 0.000
 Decimal fraction soil group C = 0.000
 Decimal fraction soil group D = 0.000
 SCS curve number for soil(AMC 2) = 32.00
 Adjusted SCS curve number for AMC 3 = 52.00
 Pervious ratio(Ap) = 0.1000 Max loss rate(Fm)= 0.079(In/Hr)
 Rainfall intensity = 5.673(In/Hr) for a 100.0 year storm
 Effective runoff coefficient used for area, (total area with modified
 rational method)(Q=KCIA) is C = 0.888
 Subarea runoff = 11.668(CFS) for 2.460(Ac.)
 Total runoff = 13.796(CFS)
 Effective area this stream = 2.74(Ac.)
 Total Study Area (Main Stream No. 1) = 2.74(Ac.)
 Area averaged Fm value = 0.079(In/Hr)
 Depth of flow = 0.305(Ft.), Average velocity = 2.479(Ft/s)
 Critical depth = 0.314(Ft.)

++++++
 Process from Point/Station 2.000 to Point/Station 3.000
 **** IMPROVED CHANNEL TRAVEL TIME ****

Upstream point elevation = 3155.800(Ft.)
 Downstream point elevation = 3153.800(Ft.)
 Channel length thru subarea = 400.000(Ft.)
 Channel base width = 3.000(Ft.)
 Slope or 'Z' of left channel bank = 50.000
 Slope or 'Z' of right channel bank = 50.000
 Estimated mean flow rate at midpoint of channel = 17.515(CFS)
 Manning's 'N' = 0.015
 Maximum depth of channel = 1.000(Ft.)
 Flow(q) thru subarea = 17.515(CFS)
 Depth of flow = 0.358(Ft.), Average velocity = 2.339(Ft/s)
 Channel flow top width = 38.818(Ft.)
 Flow Velocity = 2.34(Ft/s)
 Travel time = 2.85 min.
 Time of concentration = 8.46 min.
 Critical depth = 0.348(Ft.)
 Adding area flow to channel
 COMMERCIAL subarea type
 Decimal fraction soil group A = 1.000
 Decimal fraction soil group B = 0.000
 Decimal fraction soil group C = 0.000
 Decimal fraction soil group D = 0.000
 SCS curve number for soil(AMC 2) = 32.00
 Adjusted SCS curve number for AMC 3 = 52.00
 Pervious ratio(Ap) = 0.1000 Max loss rate(Fm)= 0.079(In/Hr)

Rainfall intensity = 4.255(In/Hr) for a 100.0 year storm
Effective runoff coefficient used for area, (total area with modified
rational method) (Q=KCIA) is C = 0.883
Subarea runoff = 7.367(CFS) for 2.890 (Ac.)
Total runoff = 21.164(CFS)
Effective area this stream = 5.63(Ac.)
Total Study Area (Main Stream No. 1) = 5.63(Ac.)
Area averaged Fm value = 0.079(In/Hr)
Depth of flow = 0.387(Ft.), Average velocity = 2.452(Ft/s)
Critical depth = 0.379(Ft.)

+++++
Process from Point/Station 3.000 to Point/Station 4.000
**** IMPROVED CHANNEL TRAVEL TIME ****

Upstream point elevation = 3153.800(Ft.)
Downstream point elevation = 3150.700(Ft.)
Channel length thru subarea = 400.620(Ft.)
Channel base width = 3.000(Ft.)
Slope or 'Z' of left channel bank = 50.000
Slope or 'Z' of right channel bank = 50.000
Estimated mean flow rate at midpoint of channel = 24.054(CFS)
Manning's 'N' = 0.015
Maximum depth of channel = 1.000(Ft.)
Flow(q) thru subarea = 24.054(CFS)
Depth of flow = 0.373(Ft.), Average velocity = 2.982(Ft/s)
Channel flow top width = 40.275(Ft.)
Flow Velocity = 2.98(Ft/s)
Travel time = 2.24 min.
Time of concentration = 10.70 min.
Critical depth = 0.398(Ft.)

Adding area flow to channel
COMMERCIAL subarea type
Decimal fraction soil group A = 1.000
Decimal fraction soil group B = 0.000
Decimal fraction soil group C = 0.000
Decimal fraction soil group D = 0.000
SCS curve number for soil(AMC 2) = 32.00
Adjusted SCS curve number for AMC 3 = 52.00
Pervious ratio(Ap) = 0.1000 Max loss rate(Fm)= 0.079(In/Hr)
Rainfall intensity = 3.610(In/Hr) for a 100.0 year storm
Effective runoff coefficient used for area, (total area with modified
rational method) (Q=KCIA) is C = 0.880
Subarea runoff = 5.697(CFS) for 2.820 (Ac.)
Total runoff = 26.860(CFS)
Effective area this stream = 8.45(Ac.)
Total Study Area (Main Stream No. 1) = 8.45(Ac.)
Area averaged Fm value = 0.079(In/Hr)
Depth of flow = 0.390(Ft.), Average velocity = 3.066(Ft/s)
Critical depth = 0.418(Ft.)

+++++
Process from Point/Station 4.000 to Point/Station 5.000
**** IMPROVED CHANNEL TRAVEL TIME ****

Upstream point elevation = 3150.700(Ft.)
Downstream point elevation = 3148.500(Ft.)
Channel length thru subarea = 217.890(Ft.)
Channel base width = 3.000(Ft.)
Slope or 'Z' of left channel bank = 50.000
Slope or 'Z' of right channel bank = 50.000

Estimated mean flow rate at midpoint of channel = 27.779(CFS)
Manning's 'N' = 0.015
Maximum depth of channel = 1.000(Ft.)
Flow(q) thru subarea = 27.779(CFS)
Depth of flow = 0.374(Ft.), Average velocity = 3.416(Ft/s)
Channel flow top width = 40.439(Ft.)
Flow Velocity = 3.42(Ft/s)
Travel time = 1.06 min.
Time of concentration = 11.76 min.
Critical depth = 0.426(Ft.)
Adding area flow to channel
COMMERCIAL subarea type
Decimal fraction soil group A = 1.000
Decimal fraction soil group B = 0.000
Decimal fraction soil group C = 0.000
Decimal fraction soil group D = 0.000
SCS curve number for soil(AMC 2) = 32.00
Adjusted SCS curve number for AMC 3 = 52.00
Pervious ratio(Ap) = 0.1000 Max loss rate(Fm)= 0.079(In/Hr)
Rainfall intensity = 3.379(In/Hr) for a 100.0 year storm
Effective runoff coefficient used for area, (total area with modified
rational method) (Q=KCIA) is C = 0.879
Subarea runoff = 1.773(CFS) for 1.190(Ac.)
Total runoff = 28.634(CFS)
Effective area this stream = 9.64(Ac.)
Total Study Area (Main Stream No. 1) = 9.64(Ac.)
Area averaged Fm value = 0.079(In/Hr)
Depth of flow = 0.379(Ft.), Average velocity = 3.442(Ft/s)
Critical depth = 0.430(Ft.)
End of computations, Total Study Area = 9.64 (Ac.)
The following figures may
be used for a unit hydrograph study of the same area.
Note: These figures do not consider reduced effective area
effects caused by confluences in the rational equation.

Area averaged pervious area fraction(Ap) = 0.100
Area averaged SCS curve number = 32.0

San Bernardino County Rational Hydrology Program

(Hydrology Manual Date - August 1986)

CIVILCADD/CIVILDESIGN Engineering Software, (c) 1989-2018 Version 9.0
Rational Hydrology Study Date: 07/06/23

100 YEAR STORM
AMC III
DEVELOPED DA2 30 AC

Program License Serial Number 6434

***** Hydrology Study Control Information *****

Rational hydrology study storm event year is 100.0
Computed rainfall intensity:
Storm year = 100.00 1 hour rainfall = 1.080 (In.)
Slope used for rainfall intensity curve b = 0.7000
Soil antecedent moisture condition (AMC) = 3

+++++
Process from Point/Station 0.000 to Point/Station 1.000
**** INITIAL AREA EVALUATION ****

COMMERCIAL subarea type
Decimal fraction soil group A = 0.550
Decimal fraction soil group B = 0.000
Decimal fraction soil group C = 0.450
Decimal fraction soil group D = 0.000
SCS curve number for soil(AMC 2) = 48.65
Adjusted SCS curve number for AMC 3 = 68.65
Pervious ratio(Ap) = 0.1000 Max loss rate(Fm)= 0.055(In/Hr)
Initial subarea data:
Initial area flow distance = 70.600(Ft.)
Top (of initial area) elevation = 3149.000(Ft.)
Bottom (of initial area) elevation = 3148.500(Ft.)
Difference in elevation = 0.500(Ft.)
Slope = 0.00708 s(%)= 0.71
TC = k(0.304)*[(length^3)/(elevation change)]^0.2
Initial area time of concentration = 4.491 min.
Rainfall intensity = 6.629(In/Hr) for a 100.0 year storm
Effective runoff coefficient used for area (Q=KCIA) is C = 0.892
Subarea runoff = 0.533(CFS)
Total initial stream area = 0.090(Ac.)
Pervious area fraction = 0.100
Initial area Fm value = 0.055(In/Hr)

+++++
Process from Point/Station 1.000 to Point/Station 2.000
**** IMPROVED CHANNEL TRAVEL TIME ****

Upstream point elevation = 3148.500(Ft.)
Downstream point elevation = 3148.000(Ft.)
Channel length thru subarea = 240.000(Ft.)

Channel base width = 3.000(Ft.)
 Slope or 'Z' of left channel bank = 50.000
 Slope or 'Z' of right channel bank = 50.000
 Estimated mean flow rate at midpoint of channel = 1.064(CFS)
 Manning's 'N' = 0.015
 Maximum depth of channel = 1.000(Ft.)
 Flow(q) thru subarea = 1.064(CFS)
 Depth of flow = 0.133(Ft.), Average velocity = 0.830(Ft/s)
 Channel flow top width = 16.289(Ft.)
 Flow Velocity = 0.83(Ft/s)
 Travel time = 4.82 min.
 Time of concentration = 9.31 min.
 Critical depth = 0.098(Ft.)
 Adding area flow to channel
 COMMERCIAL subarea type
 Decimal fraction soil group A = 0.550
 Decimal fraction soil group B = 0.000
 Decimal fraction soil group C = 0.450
 Decimal fraction soil group D = 0.000
 SCS curve number for soil(AMC 2) = 48.65
 Adjusted SCS curve number for AMC 3 = 68.65
 Pervious ratio(Ap) = 0.1000 Max loss rate(Fm)= 0.055(In/Hr)
 Rainfall intensity = 3.980(In/Hr) for a 100.0 year storm
 Effective runoff coefficient used for area, (total area with modified
 rational method)(Q=KCIA) is C = 0.887
 Subarea runoff = 0.986(CFS) for 0.340(Ac.)
 Total runoff = 1.519(CFS)
 Effective area this stream = 0.43(Ac.)
 Total Study Area (Main Stream No. 1) = 0.43(Ac.)
 Area averaged Fm value = 0.055(In/Hr)
 Depth of flow = 0.155(Ft.), Average velocity = 0.909(Ft/s)
 Critical depth = 0.115(Ft.)

++++++
 Process from Point/Station 2.000 to Point/Station 3.000
 **** IMPROVED CHANNEL TRAVEL TIME ****

Upstream point elevation = 3148.000(Ft.)
 Downstream point elevation = 3147.500(Ft.)
 Channel length thru subarea = 181.000(Ft.)
 Channel base width = 3.000(Ft.)
 Slope or 'Z' of left channel bank = 50.000
 Slope or 'Z' of right channel bank = 50.000
 Estimated mean flow rate at midpoint of channel = 2.133(CFS)
 Manning's 'N' = 0.015
 Maximum depth of channel = 1.000(Ft.)
 Flow(q) thru subarea = 2.133(CFS)
 Depth of flow = 0.169(Ft.), Average velocity = 1.101(Ft/s)
 Channel flow top width = 19.908(Ft.)
 Flow Velocity = 1.10(Ft/s)
 Travel time = 2.74 min.
 Time of concentration = 12.05 min.
 Critical depth = 0.136(Ft.)
 Adding area flow to channel
 COMMERCIAL subarea type
 Decimal fraction soil group A = 0.550
 Decimal fraction soil group B = 0.000
 Decimal fraction soil group C = 0.450
 Decimal fraction soil group D = 0.000
 SCS curve number for soil(AMC 2) = 48.65
 Adjusted SCS curve number for AMC 3 = 68.65
 Pervious ratio(Ap) = 0.1000 Max loss rate(Fm)= 0.055(In/Hr)

Rainfall intensity = 3.323(In/Hr) for a 100.0 year storm
Effective runoff coefficient used for area, (total area with modified
rational method) (Q=KCIA) is C = 0.885
Subarea runoff = 1.157(CFS) for 0.480 (Ac.)
Total runoff = 2.676(CFS)
Effective area this stream = 0.91(Ac.)
Total Study Area (Main Stream No. 1) = 0.91(Ac.)
Area averaged Fm value = 0.055(In/Hr)
Depth of flow = 0.186(Ft.), Average velocity = 1.167(Ft/s)
Critical depth = 0.150(Ft.)

++++
Process from Point/Station 2.000 to Point/Station 3.000
**** CONFLUENCE OF MINOR STREAMS ****

Along Main Stream number: 1 in normal stream number 1
Stream flow area = 0.910(Ac.)
Runoff from this stream = 2.676(CFS)
Time of concentration = 12.05 min.
Rainfall intensity = 3.323(In/Hr)
Area averaged loss rate (Fm) = 0.0553(In/Hr)
Area averaged Pervious ratio (Ap) = 0.1000

++++
Process from Point/Station 4.000 to Point/Station 5.000
**** INITIAL AREA EVALUATION ****

COMMERCIAL subarea type
Decimal fraction soil group A = 0.550
Decimal fraction soil group B = 0.000
Decimal fraction soil group C = 0.450
Decimal fraction soil group D = 0.000
SCS curve number for soil(AMC 2) = 48.65
Adjusted SCS curve number for AMC 3 = 68.65
Pervious ratio(Ap) = 0.1000 Max loss rate(Fm)= 0.055 (In/Hr)
Initial subarea data:
Initial area flow distance = 242.810(Ft.)
Top (of initial area) elevation = 3159.000(Ft.)
Bottom (of initial area) elevation = 3158.500(Ft.)
Difference in elevation = 0.500(Ft.)
Slope = 0.00206 s(%)= 0.21
TC = k(0.304)*[(length^3)/(elevation change)]^0.2
Initial area time of concentration = 9.424 min.
Rainfall intensity = 3.946(In/Hr) for a 100.0 year storm
Effective runoff coefficient used for area (Q=KCIA) is C = 0.887
Subarea runoff = 2.031(CFS)
Total initial stream area = 0.580(Ac.)
Pervious area fraction = 0.100
Initial area Fm value = 0.055(In/Hr)

++++
Process from Point/Station 5.000 to Point/Station 6.000
**** IMPROVED CHANNEL TRAVEL TIME ****

Upstream point elevation = 3158.500(Ft.)
Downstream point elevation = 3155.000(Ft.)
Channel length thru subarea = 489.530(Ft.)
Channel base width = 3.000(Ft.)
Slope or 'Z' of left channel bank = 50.000
Slope or 'Z' of right channel bank = 50.000

Estimated mean flow rate at midpoint of channel = 5.580 (CFS)
 Manning's 'N' = 0.015
 Maximum depth of channel = 1.000 (Ft.)
 Flow (q) thru subarea = 5.580 (CFS)
 Depth of flow = 0.208 (Ft.), Average velocity = 2.004 (Ft/s)
 Channel flow top width = 23.788 (Ft.)
 Flow Velocity = 2.00 (Ft/s)
 Travel time = 4.07 min.
 Time of concentration = 13.50 min.
 Critical depth = 0.211 (Ft.)
 Adding area flow to channel
 COMMERCIAL subarea type
 Decimal fraction soil group A = 0.550
 Decimal fraction soil group B = 0.000
 Decimal fraction soil group C = 0.450
 Decimal fraction soil group D = 0.000
 SCS curve number for soil (AMC 2) = 48.65
 Adjusted SCS curve number for AMC 3 = 68.65
 Pervious ratio (Ap) = 0.1000 Max loss rate (Fm) = 0.055 (In/Hr)
 Rainfall intensity = 3.069 (In/Hr) for a 100.0 year storm
 Effective runoff coefficient used for area, (total area with modified
 rational method) (Q=KCIA) is C = 0.884
 Subarea runoff = 7.001 (CFS) for 2.750 (Ac.)
 Total runoff = 9.032 (CFS)
 Effective area this stream = 3.33 (Ac.)
 Total Study Area (Main Stream No. 1) = 4.24 (Ac.)
 Area averaged Fm value = 0.055 (In/Hr)
 Depth of flow = 0.254 (Ft.), Average velocity = 2.263 (Ft/s)
 Critical depth = 0.262 (Ft.)

++++++
 Process from Point/Station 6.000 to Point/Station 7.000
 **** IMPROVED CHANNEL TRAVEL TIME ****

Upstream point elevation = 3155.000 (Ft.)
 Downstream point elevation = 3152.000 (Ft.)
 Channel length thru subarea = 400.000 (Ft.)
 Channel base width = 3.000 (Ft.)
 Slope or 'Z' of left channel bank = 50.000
 Slope or 'Z' of right channel bank = 50.000
 Estimated mean flow rate at midpoint of channel = 12.019 (CFS)
 Manning's 'N' = 0.015
 Maximum depth of channel = 1.000 (Ft.)
 Flow (q) thru subarea = 12.019 (CFS)
 Depth of flow = 0.283 (Ft.), Average velocity = 2.476 (Ft/s)
 Channel flow top width = 31.302 (Ft.)
 Flow Velocity = 2.48 (Ft/s)
 Travel time = 2.69 min.
 Time of concentration = 16.19 min.
 Critical depth = 0.297 (Ft.)
 Adding area flow to channel
 COMMERCIAL subarea type
 Decimal fraction soil group A = 0.550
 Decimal fraction soil group B = 0.000
 Decimal fraction soil group C = 0.450
 Decimal fraction soil group D = 0.000
 SCS curve number for soil (AMC 2) = 48.65
 Adjusted SCS curve number for AMC 3 = 68.65
 Pervious ratio (Ap) = 0.1000 Max loss rate (Fm) = 0.055 (In/Hr)
 Rainfall intensity = 2.702 (In/Hr) for a 100.0 year storm
 Effective runoff coefficient used for area, (total area with modified
 rational method) (Q=KCIA) is C = 0.882

Subarea runoff = 5.904(CFS) for 2.940(Ac.)
Total runoff = 14.936(CFS)
Effective area this stream = 6.27(Ac.)
Total Study Area (Main Stream No. 1) = 7.18(Ac.)
Area averaged Fm value = 0.055(In/Hr)
Depth of flow = 0.309(Ft.), Average velocity = 2.615(Ft/s)
Critical depth = 0.324(Ft.)

++++
Process from Point/Station 7.000 to Point/Station 8.000
**** IMPROVED CHANNEL TRAVEL TIME ****

Upstream point elevation = 3152.000(Ft.)
Downstream point elevation = 3149.500(Ft.)
Channel length thru subarea = 400.000(Ft.)
Channel base width = 3.000(Ft.)
Slope or 'Z' of left channel bank = 50.000
Slope or 'Z' of right channel bank = 50.000
Estimated mean flow rate at midpoint of channel = 17.420(CFS)
Manning's 'N' = 0.015
Maximum depth of channel = 1.000(Ft.)
Flow(q) thru subarea = 17.420(CFS)
Depth of flow = 0.342(Ft.), Average velocity = 2.539(Ft/s)
Channel flow top width = 37.165(Ft.)
Flow Velocity = 2.54(Ft/s)
Travel time = 2.63 min.
Time of concentration = 18.81 min.
Critical depth = 0.348(Ft.)

Adding area flow to channel

COMMERCIAL subarea type

Decimal fraction soil group A = 0.550
Decimal fraction soil group B = 0.000
Decimal fraction soil group C = 0.450
Decimal fraction soil group D = 0.000
SCS curve number for soil(AMC 2) = 48.65
Adjusted SCS curve number for AMC 3 = 68.65
Pervious ratio(Ap) = 0.1000 Max loss rate(Fm)= 0.055(In/Hr)
Rainfall intensity = 2.432(In/Hr) for a 100.0 year storm
Effective runoff coefficient used for area, (total area with modified
rational method) (Q=KCIA) is C = 0.880
Subarea runoff = 4.895(CFS) for 3.000(Ac.)
Total runoff = 19.830(CFS)
Effective area this stream = 9.27(Ac.)
Total Study Area (Main Stream No. 1) = 10.18(Ac.)
Area averaged Fm value = 0.055(In/Hr)
Depth of flow = 0.360(Ft.), Average velocity = 2.623(Ft/s)
Critical depth = 0.367(Ft.)

++++
Process from Point/Station 8.000 to Point/Station 9.000
**** IMPROVED CHANNEL TRAVEL TIME ****

Upstream point elevation = 3149.500(Ft.)
Downstream point elevation = 3149.000(Ft.)
Channel length thru subarea = 127.460(Ft.)
Channel base width = 3.000(Ft.)
Slope or 'Z' of left channel bank = 50.000
Slope or 'Z' of right channel bank = 50.000
Estimated mean flow rate at midpoint of channel = 20.617(CFS)
Manning's 'N' = 0.015
Maximum depth of channel = 1.000(Ft.)

Flow(q) thru subarea = 20.617(CFS)
 Depth of flow = 0.402(Ft.), Average velocity = 2.225(Ft/s)
 Channel flow top width = 43.156(Ft.)
 Flow Velocity = 2.22(Ft/s)
 Travel time = 0.95 min.
 Time of concentration = 19.77 min.
 Critical depth = 0.375(Ft.)
 Adding area flow to channel
 COMMERCIAL subarea type
 Decimal fraction soil group A = 0.550
 Decimal fraction soil group B = 0.000
 Decimal fraction soil group C = 0.450
 Decimal fraction soil group D = 0.000
 SCS curve number for soil(AMC 2) = 48.65
 Adjusted SCS curve number for AMC 3 = 68.65
 Pervious ratio(Ap) = 0.1000 Max loss rate(Fm)= 0.055(In/Hr)
 Rainfall intensity = 2.349(In/Hr) for a 100.0 year storm
 Effective runoff coefficient used for area, (total area with modified
 rational method) (Q=KCIA) is C = 0.879
 Subarea runoff = 1.477(CFS) for 1.050(Ac.)
 Total runoff = 21.307(CFS)
 Effective area this stream = 10.32(Ac.)
 Total Study Area (Main Stream No. 1) = 11.23(Ac.)
 Area averaged Fm value = 0.055(In/Hr)
 Depth of flow = 0.407(Ft.), Average velocity = 2.243(Ft/s)
 Critical depth = 0.379(Ft.)

++++++
 Process from Point/Station 9.000 to Point/Station 3.000
 **** IMPROVED CHANNEL TRAVEL TIME ****

Upstream point elevation = 3149.000(Ft.)
 Downstream point elevation = 3147.500(Ft.)
 Channel length thru subarea = 95.400(Ft.)
 Channel base width = 3.000(Ft.)
 Slope or 'Z' of left channel bank = 50.000
 Slope or 'Z' of right channel bank = 50.000
 Manning's 'N' = 0.015
 Maximum depth of channel = 1.000(Ft.)
 Flow(q) thru subarea = 21.307(CFS)
 Depth of flow = 0.307(Ft.), Average velocity = 3.772(Ft/s)
 Channel flow top width = 33.744(Ft.)
 Flow Velocity = 3.77(Ft/s)
 Travel time = 0.42 min.
 Time of concentration = 20.19 min.
 Critical depth = 0.379(Ft.)

++++++
 Process from Point/Station 9.000 to Point/Station 3.000
 **** CONFLUENCE OF MINOR STREAMS ****

Along Main Stream number: 1 in normal stream number 2
 Stream flow area = 10.320(Ac.)
 Runoff from this stream = 21.307(CFS)
 Time of concentration = 20.19 min.
 Rainfall intensity = 2.315(In/Hr)
 Area averaged loss rate (Fm) = 0.0553(In/Hr)
 Area averaged Pervious ratio (Ap) = 0.1000
 Summary of stream data:

Stream Flow rate	Area	TC	Fm	Rainfall Intensity
------------------	------	----	----	--------------------

No.	(CFS)	(Ac.)	(min)	(In/Hr)	(In/Hr)
1	2.68	0.910	12.05	0.055	3.323
2	21.31	10.320	20.19	0.055	2.315
Qmax(1) =					
	1.000 *	1.000 *	2.676)	+	
	1.446 *	0.597 *	21.307)	+=	21.062
Qmax(2) =					
	0.692 *	1.000 *	2.676)	+	
	1.000 *	1.000 *	21.307)	+=	23.158

Total of 2 streams to confluence:

Flow rates before confluence point:

2.676 21.307

Maximum flow rates at confluence using above data:

21.062 23.158

Area of streams before confluence:

0.910 10.320

Effective area values after confluence:

7.069 11.230

Results of confluence:

Total flow rate = 23.158(CFS)

Time of concentration = 20.190 min.

Effective stream area after confluence = 11.230(Ac.)

Study area average Pervious fraction(Ap) = 0.100

Study area average soil loss rate(Fm) = 0.055(In/Hr)

Study area total (this main stream) = 11.23(Ac.)

End of computations, Total Study Area = 11.23 (Ac.)

The following figures may

be used for a unit hydrograph study of the same area.

Note: These figures do not consider reduced effective area effects caused by confluences in the rational equation.

Area averaged pervious area fraction(Ap) = 0.100

Area averaged SCS curve number = 48.6

San Bernardino County Rational Hydrology Program

(Hydrology Manual Date - August 1986)

CIVILCADD/CIVILDESIGN Engineering Software, (c) 1989-2018 Version 9.0
Rational Hydrology Study Date: 06/24/23

100 YEAR STORM
AMC III
DEVELOPED 30 DA-3

Program License Serial Number 6434

***** Hydrology Study Control Information *****

Rational hydrology study storm event year is 100.0
Computed rainfall intensity:
Storm year = 100.00 1 hour rainfall = 1.080 (In.)
Slope used for rainfall intensity curve b = 0.7000
Soil antecedent moisture condition (AMC) = 3

+++++
Process from Point/Station 0.000 to Point/Station 1.000
**** INITIAL AREA EVALUATION ****

COMMERCIAL subarea type
Decimal fraction soil group A = 1.000
Decimal fraction soil group B = 0.000
Decimal fraction soil group C = 0.000
Decimal fraction soil group D = 0.000
SCS curve number for soil(AMC 2) = 32.00
Adjusted SCS curve number for AMC 3 = 52.00
Pervious ratio(Ap) = 0.1000 Max loss rate(Fm)= 0.079(In/Hr)
Initial subarea data:
Initial area flow distance = 185.480(Ft.)
Top (of initial area) elevation = 3152.000(Ft.)
Bottom (of initial area) elevation = 3145.300(Ft.)
Difference in elevation = 6.700(Ft.)
Slope = 0.03612 s(%)= 3.61
TC = k(0.304)*[(length^3)/(elevation change)]^0.2
Initial area time of concentration = 4.771 min.
Rainfall intensity = 6.355(In/Hr) for a 100.0 year storm
Effective runoff coefficient used for area (Q=KCIA) is C = 0.889
Subarea runoff = 3.389(CFS)
Total initial stream area = 0.600(Ac.)
Pervious area fraction = 0.100
Initial area Fm value = 0.079(In/Hr)

+++++
Process from Point/Station 1.000 to Point/Station 2.000
**** IMPROVED CHANNEL TRAVEL TIME ****

Upstream point elevation = 3145.300(Ft.)
Downstream point elevation = 3141.000(Ft.)
Channel length thru subarea = 614.200(Ft.)

Channel base width = 3.000(Ft.)
 Slope or 'Z' of left channel bank = 50.000
 Slope or 'Z' of right channel bank = 50.000
 Estimated mean flow rate at midpoint of channel = 6.055(CFS)
 Manning's 'N' = 0.015
 Maximum depth of channel = 1.000(Ft.)
 Flow(q) thru subarea = 6.055(CFS)
 Depth of flow = 0.216(Ft.), Average velocity = 2.030(Ft/s)
 Channel flow top width = 24.608(Ft.)
 Flow Velocity = 2.03(Ft/s)
 Travel time = 5.04 min.
 Time of concentration = 9.81 min.
 Critical depth = 0.219(Ft.)
 Adding area flow to channel
 COMMERCIAL subarea type
 Decimal fraction soil group A = 1.000
 Decimal fraction soil group B = 0.000
 Decimal fraction soil group C = 0.000
 Decimal fraction soil group D = 0.000
 SCS curve number for soil(AMC 2) = 32.00
 Adjusted SCS curve number for AMC 3 = 52.00
 Pervious ratio(Ap) = 0.1000 Max loss rate(Fm)= 0.079(In/Hr)
 Rainfall intensity = 3.836(In/Hr) for a 100.0 year storm
 Effective runoff coefficient used for area, (total area with modified
 rational method)(Q=KCIA) is C = 0.882
 Subarea runoff = 5.267(CFS) for 1.960(Ac.)
 Total runoff = 8.656(CFS)
 Effective area this stream = 2.56(Ac.)
 Total Study Area (Main Stream No. 1) = 2.56(Ac.)
 Area averaged Fm value = 0.079(In/Hr)
 Depth of flow = 0.251(Ft.), Average velocity = 2.222(Ft/s)
 Critical depth = 0.256(Ft.)

++++++
 Process from Point/Station 1.000 to Point/Station 2.000
 **** CONFLUENCE OF MINOR STREAMS ****

Along Main Stream number: 1 in normal stream number 1
 Stream flow area = 2.560(Ac.)
 Runoff from this stream = 8.656(CFS)
 Time of concentration = 9.81 min.
 Rainfall intensity = 3.836(In/Hr)
 Area averaged loss rate (Fm) = 0.0785(In/Hr)
 Area averaged Pervious ratio (Ap) = 0.1000

++++++
 Process from Point/Station 3.000 to Point/Station 4.000
 **** INITIAL AREA EVALUATION ****

COMMERCIAL subarea type
 Decimal fraction soil group A = 1.000
 Decimal fraction soil group B = 0.000
 Decimal fraction soil group C = 0.000
 Decimal fraction soil group D = 0.000
 SCS curve number for soil(AMC 2) = 32.00
 Adjusted SCS curve number for AMC 3 = 52.00
 Pervious ratio(Ap) = 0.1000 Max loss rate(Fm)= 0.079(In/Hr)
 Initial subarea data:
 Initial area flow distance = 248.180(Ft.)
 Top (of initial area) elevation = 3149.000(Ft.)
 Bottom (of initial area) elevation = 3147.700(Ft.)

Difference in elevation = 1.300(Ft.)
Slope = 0.00524 s(%)= 0.52
TC = k(0.304)*[(length^3)/(elevation change)]^0.2
Initial area time of concentration = 7.888 min.
Rainfall intensity = 4.470(In/Hr) for a 100.0 year storm
Effective runoff coefficient used for area (Q=KCIA) is C = 0.884
Subarea runoff = 3.557(CFS)
Total initial stream area = 0.900(Ac.)
Pervious area fraction = 0.100
Initial area Fm value = 0.079(In/Hr)

++++
Process from Point/Station 4.000 to Point/Station 5.000
**** IMPROVED CHANNEL TRAVEL TIME ****

Upstream point elevation = 3147.700(Ft.)
Downstream point elevation = 3141.000(Ft.)
Channel length thru subarea = 621.000(Ft.)
Channel base width = 3.000(Ft.)
Slope or 'Z' of left channel bank = 50.000
Slope or 'Z' of right channel bank = 50.000
Estimated mean flow rate at midpoint of channel = 5.828 (CFS)
Manning's 'N' = 0.015
Maximum depth of channel = 1.000(Ft.)
Flow(q) thru subarea = 5.828(CFS)
Depth of flow = 0.194(Ft.), Average velocity = 2.363(Ft/s)
Channel flow top width = 22.412(Ft.)
Flow Velocity = 2.36(Ft/s)
Travel time = 4.38 min.
Time of concentration = 12.27 min.
Critical depth = 0.215(Ft.)
Adding area flow to channel
COMMERCIAL subarea type
Decimal fraction soil group A = 1.000
Decimal fraction soil group B = 0.000
Decimal fraction soil group C = 0.000
Decimal fraction soil group D = 0.000
SCS curve number for soil(AMC 2) = 32.00
Adjusted SCS curve number for AMC 3 = 52.00
Pervious ratio(Ap) = 0.1000 Max loss rate(Fm)= 0.079(In/Hr)
Rainfall intensity = 3.281(In/Hr) for a 100.0 year storm
Effective runoff coefficient used for area, (total area with modified
rational method) (Q=KCIA) is C = 0.878
Subarea runoff = 4.484(CFS) for 1.890(Ac.)
Total runoff = 8.041(CFS)
Effective area this stream = 2.79(Ac.)
Total Study Area (Main Stream No. 1) = 5.35(Ac.)
Area averaged Fm value = 0.079(In/Hr)
Depth of flow = 0.222(Ft.), Average velocity = 2.563(Ft/s)
Critical depth = 0.248(Ft.)

++++
Process from Point/Station 5.000 to Point/Station 2.000
**** CONFLUENCE OF MINOR STREAMS ****

Along Main Stream number: 1 in normal stream number 2
Stream flow area = 2.790(Ac.)
Runoff from this stream = 8.041(CFS)
Time of concentration = 12.27 min.
Rainfall intensity = 3.281(In/Hr)
Area averaged loss rate (Fm) = 0.0785(In/Hr)

Area averaged Pervious ratio (Ap) = 0.1000
Summary of stream data:

Stream No.	Flow rate (CFS)	Area (Ac.)	TC (min)	Fm (In/Hr)	Rainfall Intensity (In/Hr)
1	8.66	2.560	9.81	0.079	3.836
2	8.04	2.790	12.27	0.079	3.281
Qmax(1) =					
	1.000 *	1.000 *	8.656)	+	
	1.173 *	0.800 *	8.041)	+=	16.203
Qmax(2) =					
	0.852 *	1.000 *	8.656)	+	
	1.000 *	1.000 *	8.041)	+=	15.419

Total of 2 streams to confluence:

Flow rates before confluence point:
8.656 8.041

Maximum flow rates at confluence using above data:
16.203 15.419

Area of streams before confluence:
2.560 2.790

Effective area values after confluence:
4.792 5.350

Results of confluence:

Total flow rate = 16.203(CFS)

Time of concentration = 9.814 min.

Effective stream area after confluence = 4.792(Ac.)

Study area average Pervious fraction(Ap) = 0.100

Study area average soil loss rate(Fm) = 0.079(In/Hr)

Study area total (this main stream) = 5.35(Ac.)

End of computations, Total Study Area = 5.35 (Ac.)

The following figures may

be used for a unit hydrograph study of the same area.

Note: These figures do not consider reduced effective area effects caused by confluences in the rational equation.

Area averaged pervious area fraction(Ap) = 0.100

Area averaged SCS curve number = 32.0

U n i t H y d r o g r a p h A n a l y s i s

Copyright (c) CIVILCADD/CIVILDESIGN, 1989 - 2018, Version 9.0

Study date 06/28/23

+++++

San Bernardino County Synthetic Unit Hydrology Method
Manual date - August 1986

Program License Serial Number 6434

**100 YEAR 24 HOUR STORM
AMC III
DEVELOPED 30 AC DAI**

Storm Event Year = 100

Antecedent Moisture Condition = 3

English (in-lb) Input Units Used

English Rainfall Data (Inches) Input Values Used

English Units used in output format

Area averaged rainfall intensity isohyetal data:

Sub-Area (Ac.)	Duration (hours)	Isohyetal (In)
Rainfall data for year 100		
9.64	1	1.08

Rainfall data for year 100
9.64 6 2.01

Rainfall data for year 100
9.64 24 3.44

+++++

***** Area-averaged max loss rate, Fm *****

SCS curve No. (AMCII)	SCS curve NO. (AMC 3)	Area (Ac.)	Area Fraction	Fp(Fig C6) (In/Hr)	Ap (dec.)	Fm (In/Hr)
56.0	75.8	9.64	1.000	0.440	0.050	0.022

Area-averaged adjusted loss rate Fm (In/Hr) = 0.022

***** Area-Averaged low loss rate fraction, Yb *****

Area	Area	SCS CN	SCS CN	S	Pervious
------	------	--------	--------	---	----------

(Ac.)	Fract	(AMC2)	(AMC3)		Yield Fr
0.48	0.050	56.0	75.8	3.19	0.381
9.16	0.950	98.0	98.0	0.20	0.932

Area-averaged catchment yield fraction, Y = 0.905
 Area-averaged low loss fraction, Yb = 0.095
 User entry of time of concentration = 0.196 (hours)
 ++++++
 Watershed area = 9.64 (Ac.)
 Catchment Lag time = 0.157 hours
 Unit interval = 5.000 minutes
 Unit interval percentage of lag time = 53.1463
 Hydrograph baseflow = 0.00 (CFS)
 Average maximum watershed loss rate (Fm) = 0.022 (In/Hr)
 Average low loss rate fraction (Yb) = 0.095 (decimal)
 DESERT S-Graph Selected
 Computed peak 5-minute rainfall = 0.512 (In)
 Computed peak 30-minute rainfall = 0.877 (In)
 Specified peak 1-hour rainfall = 1.080 (In)
 Computed peak 3-hour rainfall = 1.581 (In)
 Specified peak 6-hour rainfall = 2.010 (In)
 Specified peak 24-hour rainfall = 3.440 (In)

Rainfall depth area reduction factors:
 Using a total area of 9.64 (Ac.) (Ref: fig. E-4)

5-minute factor = 1.000	Adjusted rainfall = 0.512 (In)
30-minute factor = 1.000	Adjusted rainfall = 0.877 (In)
1-hour factor = 1.000	Adjusted rainfall = 1.080 (In)
3-hour factor = 1.000	Adjusted rainfall = 1.581 (In)
6-hour factor = 1.000	Adjusted rainfall = 2.010 (In)
24-hour factor = 1.000	Adjusted rainfall = 3.440 (In)

U n i t H y d r o g r a p h

+++++

Interval Number	'S' Graph Mean values	Unit Hydrograph ((CFS))
	(K = 116.58 (CFS))	
1	4.409	5.140
2	34.139	34.660
3	63.230	33.916
4	75.779	14.630
5	83.066	8.496
6	88.004	5.757
7	91.307	3.851
8	93.778	2.881
9	95.599	2.123
10	96.953	1.578
11	97.854	1.051
12	98.439	0.681
13	99.072	0.738
14	99.605	0.621
15	100.000	0.461

Total soil rain loss = 0.24 (In)
 Total effective rainfall = 3.20 (In)
 Peak flow rate in flood hydrograph = 24.25 (CFS)

 ++++++
 24 - H O U R S T O R M
 R u n o f f H y d r o g r a p h

Hydrograph in 5 Minute intervals ((CFS))

Time(h+m)	Volume Ac.Ft	Q(CFS)	0	7.5	15.0	22.5	30.0
0+ 5	0.0001	0.02	Q				
0+10	0.0013	0.17	Q				
0+15	0.0034	0.31	Q				
0+20	0.0060	0.37	Q				
0+25	0.0088	0.41	Q				
0+30	0.0118	0.43	Q				
0+35	0.0149	0.45	Q				
0+40	0.0181	0.47	Q				
0+45	0.0214	0.48	Q				
0+50	0.0247	0.48	Q				
0+55	0.0281	0.49	Q				
1+ 0	0.0315	0.49	Q				
1+ 5	0.0349	0.50	Q				
1+10	0.0384	0.50	Q				
1+15	0.0419	0.51	Q				
1+20	0.0454	0.51	Q				
1+25	0.0489	0.51	Q				
1+30	0.0524	0.51	Q				
1+35	0.0560	0.51	Q				
1+40	0.0595	0.52	Q				
1+45	0.0631	0.52	Q				
1+50	0.0667	0.52	QV				
1+55	0.0703	0.52	QV				
2+ 0	0.0739	0.52	QV				
2+ 5	0.0775	0.52	QV				
2+10	0.0811	0.53	QV				
2+15	0.0847	0.53	QV				
2+20	0.0884	0.53	QV				
2+25	0.0921	0.53	QV				
2+30	0.0957	0.53	QV				
2+35	0.0994	0.54	QV				
2+40	0.1031	0.54	QV				
2+45	0.1069	0.54	QV				
2+50	0.1106	0.54	QV				
2+55	0.1144	0.54	QV				
3+ 0	0.1181	0.55	QV				
3+ 5	0.1219	0.55	QV				
3+10	0.1257	0.55	QV				
3+15	0.1295	0.55	Q V				
3+20	0.1333	0.56	Q V				
3+25	0.1372	0.56	Q V				
3+30	0.1410	0.56	Q V				
3+35	0.1449	0.56	Q V				
3+40	0.1488	0.56	Q V				
3+45	0.1527	0.57	Q V				
3+50	0.1566	0.57	Q V				
3+55	0.1605	0.57	Q V				
4+ 0	0.1645	0.57	Q V				
4+ 5	0.1685	0.58	Q V				
4+10	0.1724	0.58	Q V				
4+15	0.1764	0.58	Q V				
4+20	0.1805	0.58	Q V				
4+25	0.1845	0.59	Q V				

4+30	0.1885	0.59	Q	V
4+35	0.1926	0.59	Q	V
4+40	0.1967	0.59	Q	V
4+45	0.2008	0.60	Q	V
4+50	0.2049	0.60	Q	V
4+55	0.2091	0.60	Q	V
5+ 0	0.2132	0.60	Q	V
5+ 5	0.2174	0.61	Q	V
5+10	0.2216	0.61	Q	V
5+15	0.2258	0.61	Q	V
5+20	0.2301	0.62	Q	V
5+25	0.2343	0.62	Q	V
5+30	0.2386	0.62	Q	V
5+35	0.2429	0.62	Q	V
5+40	0.2472	0.63	Q	V
5+45	0.2516	0.63	Q	V
5+50	0.2559	0.63	Q	V
5+55	0.2603	0.64	Q	V
6+ 0	0.2647	0.64	Q	V
6+ 5	0.2691	0.64	Q	V
6+10	0.2736	0.65	Q	V
6+15	0.2781	0.65	Q	V
6+20	0.2826	0.65	Q	V
6+25	0.2871	0.66	Q	V
6+30	0.2916	0.66	Q	V
6+35	0.2962	0.66	Q	V
6+40	0.3008	0.67	Q	V
6+45	0.3054	0.67	Q	V
6+50	0.3100	0.67	Q	V
6+55	0.3147	0.68	Q	V
7+ 0	0.3194	0.68	Q	V
7+ 5	0.3241	0.68	Q	V
7+10	0.3288	0.69	Q	V
7+15	0.3336	0.69	Q	V
7+20	0.3384	0.70	Q	V
7+25	0.3432	0.70	Q	V
7+30	0.3481	0.70	Q	V
7+35	0.3529	0.71	Q	V
7+40	0.3578	0.71	Q	V
7+45	0.3628	0.72	Q	V
7+50	0.3677	0.72	Q	V
7+55	0.3727	0.73	Q	V
8+ 0	0.3778	0.73	Q	V
8+ 5	0.3828	0.73	Q	V
8+10	0.3879	0.74	Q	V
8+15	0.3930	0.74	Q	V
8+20	0.3982	0.75	Q	V
8+25	0.4034	0.75	Q	V
8+30	0.4086	0.76	Q	V
8+35	0.4139	0.76	Q	V
8+40	0.4192	0.77	Q	V
8+45	0.4245	0.77	Q	V
8+50	0.4298	0.78	Q	V
8+55	0.4352	0.78	Q	V
9+ 0	0.4407	0.79	Q	V
9+ 5	0.4462	0.80	Q	V
9+10	0.4517	0.80	Q	V
9+15	0.4572	0.81	Q	V
9+20	0.4628	0.81	Q	V
9+25	0.4685	0.82	Q	V
9+30	0.4742	0.82	Q	V
9+35	0.4799	0.83	Q	V
9+40	0.4856	0.84	Q	V

9+45	0.4915	0.84	Q	V			
9+50	0.4973	0.85	Q	V			
9+55	0.5032	0.86	Q	V			
10+ 0	0.5092	0.86	Q	V			
10+ 5	0.5152	0.87	Q	V			
10+10	0.5212	0.88	Q	V			
10+15	0.5273	0.89	Q	V			
10+20	0.5335	0.89	Q	V			
10+25	0.5397	0.90	Q	V			
10+30	0.5460	0.91	Q	V			
10+35	0.5523	0.92	Q	V			
10+40	0.5586	0.93	Q	V			
10+45	0.5651	0.93	Q	V			
10+50	0.5716	0.94	Q	V			
10+55	0.5781	0.95	Q	V			
11+ 0	0.5847	0.96	Q	V			
11+ 5	0.5914	0.97	Q	V			
11+10	0.5982	0.98	Q	V			
11+15	0.6050	0.99	Q	V			
11+20	0.6119	1.00	Q	V			
11+25	0.6188	1.01	Q	V			
11+30	0.6259	1.02	Q	V			
11+35	0.6330	1.03	Q	V			
11+40	0.6402	1.04	Q	V			
11+45	0.6474	1.06	Q	V			
11+50	0.6548	1.07	Q	V			
11+55	0.6622	1.08	Q	V			
12+ 0	0.6698	1.09	Q	V			
12+ 5	0.6773	1.10	Q	V			
12+10	0.6848	1.08	Q	V			
12+15	0.6920	1.06	Q	V			
12+20	0.6993	1.06	Q	V			
12+25	0.7066	1.06	Q	V			
12+30	0.7140	1.07	Q	V			
12+35	0.7215	1.08	Q	V			
12+40	0.7290	1.10	Q	V			
12+45	0.7367	1.11	Q	V			
12+50	0.7444	1.13	Q	V			
12+55	0.7523	1.14	Q	V			
13+ 0	0.7603	1.16	Q	V			
13+ 5	0.7684	1.18	Q	V			
13+10	0.7767	1.20	Q	V			
13+15	0.7851	1.22	Q	V			
13+20	0.7936	1.24	Q	V			
13+25	0.8024	1.27	Q	V			
13+30	0.8113	1.29	Q	V			
13+35	0.8203	1.32	Q	V			
13+40	0.8296	1.34	Q	V			
13+45	0.8390	1.37	Q	V			
13+50	0.8487	1.40	Q	V			
13+55	0.8586	1.44	Q	V			
14+ 0	0.8687	1.47	Q	V			
14+ 5	0.8791	1.51	Q	V			
14+10	0.8898	1.55	Q	V			
14+15	0.9007	1.59	Q	V			
14+20	0.9119	1.63	Q	V			
14+25	0.9235	1.68	Q	V			
14+30	0.9354	1.73	Q	V			
14+35	0.9477	1.79	Q	V			
14+40	0.9604	1.85	Q	V			
14+45	0.9736	1.91	Q	V			
14+50	0.9873	1.99	Q	V			
14+55	1.0015	2.07	Q	V			

15+ 0	1.0165	2.17	Q		V		
15+ 5	1.0321	2.27	Q		V		
15+10	1.0487	2.40	Q		V		
15+15	1.0661	2.53	Q		V		
15+20	1.0847	2.70	Q		V		
15+25	1.1044	2.86	Q		V		
15+30	1.1246	2.93	Q		V		
15+35	1.1455	3.04	Q		V		
15+40	1.1683	3.31	Q		V		
15+45	1.1936	3.67	Q		V		
15+50	1.2227	4.23	Q		V		
15+55	1.2574	5.03	Q		V		
16+ 0	1.3030	6.63			V		
16+ 5	1.3794	11.10		Q	V		
16+10	1.5464	24.25				V	Q
16+15	1.7037	22.84				V	Q
16+20	1.7940	13.11			Q		
16+25	1.8571	9.16		Q		V	
16+30	1.9063	7.15				V	
16+35	1.9459	5.74				V	
16+40	1.9791	4.82				V	
16+45	2.0071	4.07				V	
16+50	2.0310	3.48				V	
16+55	2.0515	2.97				V	
17+ 0	2.0693	2.59				V	
17+ 5	2.0861	2.43				V	
17+10	2.1012	2.21	Q			V	
17+15	2.1149	1.98	Q			V	
17+20	2.1262	1.65	Q			V	
17+25	2.1369	1.55	Q			V	
17+30	2.1470	1.47	Q			V	
17+35	2.1566	1.40	Q			V	
17+40	2.1658	1.34	Q			V	
17+45	2.1746	1.28	Q			V	
17+50	2.1831	1.23	Q			V	
17+55	2.1913	1.19	Q			V	
18+ 0	2.1992	1.15	Q			V	
18+ 5	2.2069	1.12	Q			V	
18+10	2.2146	1.12	Q			V	
18+15	2.2223	1.12	Q			V	
18+20	2.2300	1.11	Q			V	
18+25	2.2374	1.09	Q			V	
18+30	2.2448	1.07	Q			V	
18+35	2.2520	1.05	Q			V	
18+40	2.2591	1.03	Q			V	
18+45	2.2660	1.01	Q			V	
18+50	2.2728	0.99	Q			V	
18+55	2.2795	0.97	Q			V	
19+ 0	2.2860	0.95	Q			V	
19+ 5	2.2925	0.93	Q			V	
19+10	2.2988	0.92	Q			V	
19+15	2.3050	0.90	Q			V	
19+20	2.3111	0.89	Q			V	
19+25	2.3171	0.87	Q			V	
19+30	2.3230	0.86	Q			V	
19+35	2.3289	0.84	Q			V	
19+40	2.3346	0.83	Q			V	
19+45	2.3402	0.82	Q			V	
19+50	2.3458	0.81	Q			V	
19+55	2.3513	0.80	Q			V	
20+ 0	2.3567	0.78	Q			V	
20+ 5	2.3620	0.77	Q			V	
20+10	2.3673	0.76	Q			V	

20+15	2.3724	0.75	Q	V
20+20	2.3776	0.74	Q	V
20+25	2.3826	0.73	Q	V
20+30	2.3876	0.73	Q	V
20+35	2.3926	0.72	Q	V
20+40	2.3974	0.71	Q	V
20+45	2.4023	0.70	Q	V
20+50	2.4070	0.69	Q	V
20+55	2.4117	0.68	Q	V
21+ 0	2.4164	0.68	Q	V
21+ 5	2.4210	0.67	Q	V
21+10	2.4256	0.66	Q	V
21+15	2.4301	0.66	Q	V
21+20	2.4346	0.65	Q	V
21+25	2.4390	0.64	Q	V
21+30	2.4434	0.64	Q	V
21+35	2.4477	0.63	Q	V
21+40	2.4520	0.62	Q	V
21+45	2.4563	0.62	Q	V
21+50	2.4605	0.61	Q	V
21+55	2.4647	0.61	Q	V
22+ 0	2.4688	0.60	Q	V
22+ 5	2.4729	0.60	Q	V
22+10	2.4770	0.59	Q	V
22+15	2.4810	0.59	Q	V
22+20	2.4850	0.58	Q	V
22+25	2.4890	0.58	Q	V
22+30	2.4929	0.57	Q	V
22+35	2.4968	0.57	Q	V
22+40	2.5007	0.56	Q	V
22+45	2.5045	0.56	Q	V
22+50	2.5084	0.55	Q	V
22+55	2.5121	0.55	Q	V
23+ 0	2.5159	0.54	Q	V
23+ 5	2.5196	0.54	Q	V
23+10	2.5233	0.54	Q	V
23+15	2.5270	0.53	Q	V
23+20	2.5306	0.53	Q	V
23+25	2.5342	0.52	Q	V
23+30	2.5378	0.52	Q	V
23+35	2.5414	0.52	Q	V
23+40	2.5449	0.51	Q	V
23+45	2.5484	0.51	Q	V
23+50	2.5519	0.51	Q	V
23+55	2.5554	0.50	Q	V
24+ 0	2.5588	0.50	Q	V
24+ 5	2.5621	0.48	Q	V
24+10	2.5644	0.33	Q	V
24+15	2.5656	0.18	Q	V
24+20	2.5664	0.12	Q	V
24+25	2.5670	0.08	Q	V
24+30	2.5674	0.06	Q	V
24+35	2.5677	0.04	Q	V
24+40	2.5680	0.03	Q	V
24+45	2.5681	0.02	Q	V
24+50	2.5682	0.02	Q	V
24+55	2.5683	0.01	Q	V
25+ 0	2.5683	0.01	Q	V
25+ 5	2.5684	0.00	Q	V
25+10	2.5684	0.00	Q	V

Unit Hydrograph Analysis

Copyright (c) CIVILCADD/CIVILDESIGN, 1989 - 2018, Version 9.0

Study date 07/07/23

+++++

San Bernardino County Synthetic Unit Hydrology Method
Manual date - August 1986

Program License Serial Number 6434

**100 YEAR 24 HOUR STORM
AMC III
DEVELOPED DA-2 30 AC**

Storm Event Year = 100

Antecedent Moisture Condition = 3

English (in-lb) Input Units Used

English Rainfall Data (Inches) Input Values Used

English Units used in output format

Area averaged rainfall intensity isohyetal data:

Sub-Area (Ac.)	Duration (hours)	Isohyetal (In)
Rainfall data for year 100		
11.23	1	1.08

Rainfall data for year 100		
11.23	6	2.01

Rainfall data for year 100		
11.23	24	3.44

+++++

***** Area-averaged max loss rate, Fm *****

SCS curve No. (AMCII)	SCS curve NO. (AMC 3)	Area (Ac.)	Area Fraction	Fp(Fig C6) (In/Hr)	Ap (dec.)	Fm (In/Hr)
56.0	75.8	11.23	1.000	0.440	0.050	0.022

Area-averaged adjusted loss rate Fm (In/Hr) = 0.022

***** Area-Averaged low loss rate fraction, Yb *****

Area (Ac.)	Area Fract	SCS CN (AMC2)	SCS CN (AMC3)	S	Pervious Yield Fr
0.56	0.050	56.0	75.8	3.19	0.381

10.67 0.950 98.0 98.0 0.20 0.932

Area-averaged catchment yield fraction, Y = 0.905
Area-averaged low loss fraction, Yb = 0.095
User entry of time of concentration = 0.227 (hours)
++++
Watershed area = 11.23(Ac.)
Catchment Lag time = 0.181 hours
Unit interval = 5.000 minutes
Unit interval percentage of lag time = 45.9897
Hydrograph baseflow = 0.00(CFS)
Average maximum watershed loss rate(Fm) = 0.022(In/Hr)
Average low loss rate fraction (Yb) = 0.095 (decimal)
DESERT S-Graph Selected
Computed peak 5-minute rainfall = 0.512(In)
Computed peak 30-minute rainfall = 0.877(In)
Specified peak 1-hour rainfall = 1.080(In)
Computed peak 3-hour rainfall = 1.581(In)
Specified peak 6-hour rainfall = 2.010(In)
Specified peak 24-hour rainfall = 3.440(In)

Rainfall depth area reduction factors:
Using a total area of 11.23(Ac.) (Ref: fig. E-4)

5-minute factor = 0.999 Adjusted rainfall = 0.512(In)
30-minute factor = 0.999 Adjusted rainfall = 0.877(In)
1-hour factor = 0.999 Adjusted rainfall = 1.079(In)
3-hour factor = 1.000 Adjusted rainfall = 1.581(In)
6-hour factor = 1.000 Adjusted rainfall = 2.010(In)
24-hour factor = 1.000 Adjusted rainfall = 3.440(In)

U n i t H y d r o g r a p h

++++
Interval 'S' Graph Unit Hydrograph
Number Mean values ((CFS))

(K = 135.81 (CFS))

1	3.451	4.687
2	25.758	30.295
3	56.612	41.904
4	70.872	19.368
5	79.110	11.187
6	84.530	7.361
7	88.510	5.406
8	91.287	3.772
9	93.477	2.974
10	95.146	2.267
11	96.452	1.774
12	97.420	1.314
13	98.049	0.854
14	98.550	0.681
15	99.102	0.749
16	99.574	0.640
17	100.000	0.579

Total soil rain loss = 0.24(In)
Total effective rainfall = 3.20(In)
Peak flow rate in flood hydrograph = 27.69(CFS)

 ++++++
 24 - H O U R S T O R M
 R u n o f f H y d r o g r a p h

Hydrograph in 5 Minute intervals ((CFS))

Time (h+m)	Volume Ac.Ft	Q(CFS)	0	7.5	15.0	22.5	30.0
0+ 5	0.0001	0.02	Q				
0+10	0.0011	0.15	Q				
0+15	0.0034	0.32	Q				
0+20	0.0062	0.40	Q				
0+25	0.0093	0.45	Q				
0+30	0.0126	0.49	Q				
0+35	0.0161	0.51	Q				
0+40	0.0198	0.53	Q				
0+45	0.0235	0.54	Q				
0+50	0.0273	0.55	Q				
0+55	0.0312	0.56	Q				
1+ 0	0.0351	0.57	Q				
1+ 5	0.0390	0.57	Q				
1+10	0.0430	0.58	Q				
1+15	0.0471	0.58	Q				
1+20	0.0511	0.59	Q				
1+25	0.0552	0.59	Q				
1+30	0.0593	0.60	Q				
1+35	0.0634	0.60	Q				
1+40	0.0676	0.60	Q				
1+45	0.0717	0.60	Q				
1+50	0.0759	0.60	QV				
1+55	0.0800	0.61	QV				
2+ 0	0.0842	0.61	QV				
2+ 5	0.0884	0.61	QV				
2+10	0.0927	0.61	QV				
2+15	0.0969	0.62	QV				
2+20	0.1011	0.62	QV				
2+25	0.1054	0.62	QV				
2+30	0.1097	0.62	QV				
2+35	0.1140	0.62	QV				
2+40	0.1183	0.63	QV				
2+45	0.1226	0.63	QV				
2+50	0.1270	0.63	QV				
2+55	0.1313	0.63	QV				
3+ 0	0.1357	0.64	QV				
3+ 5	0.1401	0.64	QV				
3+10	0.1445	0.64	QV				
3+15	0.1490	0.64	QV				
3+20	0.1534	0.65	Q V				
3+25	0.1579	0.65	Q V				
3+30	0.1624	0.65	Q V				
3+35	0.1669	0.65	Q V				
3+40	0.1714	0.66	Q V				
3+45	0.1759	0.66	Q V				
3+50	0.1805	0.66	Q V				
3+55	0.1851	0.66	Q V				
4+ 0	0.1896	0.67	Q V				
4+ 5	0.1943	0.67	Q V				
4+10	0.1989	0.67	Q V				
4+15	0.2035	0.68	Q V				
4+20	0.2082	0.68	Q V				
4+25	0.2129	0.68	Q V				

4+30	0.2176	0.68	Q	V
4+35	0.2224	0.69	Q	V
4+40	0.2271	0.69	Q	V
4+45	0.2319	0.69	Q	V
4+50	0.2367	0.70	Q	V
4+55	0.2415	0.70	Q	V
5+ 0	0.2463	0.70	Q	V
5+ 5	0.2512	0.71	Q	V
5+10	0.2561	0.71	Q	V
5+15	0.2610	0.71	Q	V
5+20	0.2659	0.72	Q	V
5+25	0.2709	0.72	Q	V
5+30	0.2758	0.72	Q	V
5+35	0.2808	0.73	Q	V
5+40	0.2858	0.73	Q	V
5+45	0.2909	0.73	Q	V
5+50	0.2960	0.74	Q	V
5+55	0.3011	0.74	Q	V
6+ 0	0.3062	0.74	Q	V
6+ 5	0.3113	0.75	Q	V
6+10	0.3165	0.75	Q	V
6+15	0.3217	0.75	Q	V
6+20	0.3269	0.76	Q	V
6+25	0.3322	0.76	Q	V
6+30	0.3374	0.77	Q	V
6+35	0.3428	0.77	Q	V
6+40	0.3481	0.77	Q	V
6+45	0.3534	0.78	Q	V
6+50	0.3588	0.78	Q	V
6+55	0.3643	0.79	Q	V
7+ 0	0.3697	0.79	Q	V
7+ 5	0.3752	0.80	Q	V
7+10	0.3807	0.80	Q	V
7+15	0.3862	0.80	Q	V
7+20	0.3918	0.81	Q	V
7+25	0.3974	0.81	Q	V
7+30	0.4030	0.82	Q	V
7+35	0.4087	0.82	Q	V
7+40	0.4144	0.83	Q	V
7+45	0.4202	0.83	Q	V
7+50	0.4259	0.84	Q	V
7+55	0.4317	0.84	Q	V
8+ 0	0.4376	0.85	Q	V
8+ 5	0.4435	0.85	Q	V
8+10	0.4494	0.86	Q	V
8+15	0.4553	0.86	Q	V
8+20	0.4613	0.87	Q	V
8+25	0.4673	0.88	Q	V
8+30	0.4734	0.88	Q	V
8+35	0.4795	0.89	Q	V
8+40	0.4857	0.89	Q	V
8+45	0.4918	0.90	Q	V
8+50	0.4981	0.90	Q	V
8+55	0.5043	0.91	Q	V
9+ 0	0.5107	0.92	Q	V
9+ 5	0.5170	0.92	Q	V
9+10	0.5234	0.93	Q	V
9+15	0.5299	0.94	Q	V
9+20	0.5364	0.94	Q	V
9+25	0.5429	0.95	Q	V
9+30	0.5495	0.96	Q	V
9+35	0.5562	0.97	Q	V
9+40	0.5629	0.97	Q	V

9+45	0.5696	0.98	Q	V			
9+50	0.5764	0.99	Q	V			
9+55	0.5833	1.00	Q	V			
10+ 0	0.5902	1.00	Q	V			
10+ 5	0.5972	1.01	Q	V			
10+10	0.6042	1.02	Q	V			
10+15	0.6113	1.03	Q	V			
10+20	0.6184	1.04	Q	V			
10+25	0.6256	1.05	Q	V			
10+30	0.6329	1.06	Q	V			
10+35	0.6402	1.06	Q	V			
10+40	0.6476	1.07	Q	V			
10+45	0.6551	1.08	Q	V			
10+50	0.6626	1.09	Q	V			
10+55	0.6702	1.10	Q	V			
11+ 0	0.6779	1.12	Q	V			
11+ 5	0.6857	1.13	Q	V			
11+10	0.6935	1.14	Q	V			
11+15	0.7014	1.15	Q	V			
11+20	0.7094	1.16	Q	V			
11+25	0.7175	1.17	Q	V			
11+30	0.7256	1.18	Q	V			
11+35	0.7339	1.20	Q	V			
11+40	0.7422	1.21	Q	V			
11+45	0.7506	1.22	Q	V			
11+50	0.7592	1.24	Q	V			
11+55	0.7678	1.25	Q	V			
12+ 0	0.7765	1.27	Q	V			
12+ 5	0.7853	1.28	Q	V			
12+10	0.7940	1.26	Q	V			
12+15	0.8025	1.23	Q	V			
12+20	0.8110	1.23	Q	V			
12+25	0.8195	1.24	Q	V			
12+30	0.8280	1.25	Q	V			
12+35	0.8367	1.26	Q	V			
12+40	0.8455	1.27	Q	V			
12+45	0.8543	1.29	Q	V			
12+50	0.8633	1.31	Q	V			
12+55	0.8725	1.33	Q	V			
13+ 0	0.8817	1.35	Q	V			
13+ 5	0.8911	1.37	Q	V			
13+10	0.9007	1.39	Q	V			
13+15	0.9104	1.41	Q	V			
13+20	0.9204	1.44	Q	V			
13+25	0.9304	1.46	Q	V			
13+30	0.9407	1.49	Q	V			
13+35	0.9512	1.52	Q	V			
13+40	0.9619	1.55	Q	V			
13+45	0.9728	1.59	Q	V			
13+50	0.9840	1.62	Q	V			
13+55	0.9954	1.66	Q	V			
14+ 0	1.0071	1.70	Q	V			
14+ 5	1.0191	1.74	Q	V			
14+10	1.0314	1.78	Q	V			
14+15	1.0440	1.83	Q	V			
14+20	1.0569	1.88	Q	V			
14+25	1.0703	1.94	Q	V			
14+30	1.0840	1.99	Q	V			
14+35	1.0981	2.06	Q	V			
14+40	1.1128	2.12	Q	V			
14+45	1.1279	2.20	Q	V			
14+50	1.1436	2.28	Q	V			
14+55	1.1600	2.38	Q	V			

15+ 0	1.1771	2.48	Q	V		
15+ 5	1.1951	2.61	Q	V		
15+10	1.2140	2.74	Q	V		
15+15	1.2339	2.90	Q	V		
15+20	1.2551	3.07	Q	V		
15+25	1.2775	3.26	Q	V		
15+30	1.3008	3.37	Q	V		
15+35	1.3248	3.48	Q	V		
15+40	1.3506	3.75	Q	V		
15+45	1.3791	4.15	Q	V		
15+50	1.4116	4.72	Q	V		
15+55	1.4501	5.59	Q	V		
16+ 0	1.4995	7.17	Q	V		
16+ 5	1.5794	11.60		Q	V	
16+10	1.7427	23.71			V	Q
16+15	1.9334	27.69			V	Q
16+20	2.0473	16.53			Q	V
16+25	2.1265	11.50		Q		V
16+30	2.1874	8.84				V
16+35	2.2377	7.31				V
16+40	2.2791	6.01				V
16+45	2.3146	5.16				V
16+50	2.3452	4.44				V
16+55	2.3719	3.88				V
17+ 0	2.3953	3.39				V
17+ 5	2.4156	2.96	Q			V
17+10	2.4342	2.69	Q			V
17+15	2.4517	2.55	Q			V
17+20	2.4679	2.35	Q			V
17+25	2.4828	2.16	Q			V
17+30	2.4951	1.79	Q			V
17+35	2.5067	1.68	Q			V
17+40	2.5178	1.60	Q			V
17+45	2.5283	1.53	Q			V
17+50	2.5384	1.47	Q			V
17+55	2.5482	1.41	Q			V
18+ 0	2.5576	1.36	Q			V
18+ 5	2.5667	1.32	Q			V
18+10	2.5757	1.31	Q			V
18+15	2.5848	1.32	Q			V
18+20	2.5938	1.30	Q			V
18+25	2.6026	1.28	Q			V
18+30	2.6112	1.25	Q			V
18+35	2.6197	1.23	Q			V
18+40	2.6280	1.21	Q			V
18+45	2.6361	1.18	Q			V
18+50	2.6441	1.16	Q			V
18+55	2.6520	1.14	Q			V
19+ 0	2.6597	1.12	Q			V
19+ 5	2.6672	1.10	Q			V
19+10	2.6746	1.08	Q			V
19+15	2.6819	1.06	Q			V
19+20	2.6891	1.04	Q			V
19+25	2.6962	1.02	Q			V
19+30	2.7031	1.01	Q			V
19+35	2.7099	0.99	Q			V
19+40	2.7166	0.98	Q			V
19+45	2.7233	0.96	Q			V
19+50	2.7298	0.95	Q			V
19+55	2.7362	0.93	Q			V
20+ 0	2.7425	0.92	Q			V
20+ 5	2.7488	0.91	Q			V
20+10	2.7550	0.90	Q			V

20+15	2.7610	0.88	Q			V
20+20	2.7670	0.87	Q			V
20+25	2.7730	0.86	Q			V
20+30	2.7788	0.85	Q			V
20+35	2.7846	0.84	Q			V
20+40	2.7903	0.83	Q			V
20+45	2.7960	0.82	Q			V
20+50	2.8016	0.81	Q			V
20+55	2.8071	0.80	Q			V
21+ 0	2.8125	0.79	Q			V
21+ 5	2.8179	0.78	Q			V
21+10	2.8233	0.78	Q			V
21+15	2.8286	0.77	Q			V
21+20	2.8338	0.76	Q			V
21+25	2.8390	0.75	Q			V
21+30	2.8441	0.74	Q			V
21+35	2.8492	0.74	Q			V
21+40	2.8542	0.73	Q			V
21+45	2.8592	0.72	Q			V
21+50	2.8641	0.72	Q			V
21+55	2.8690	0.71	Q			V
22+ 0	2.8739	0.70	Q			V
22+ 5	2.8787	0.70	Q			V
22+10	2.8834	0.69	Q			V
22+15	2.8882	0.69	Q			V
22+20	2.8928	0.68	Q			V
22+25	2.8975	0.67	Q			V
22+30	2.9021	0.67	Q			V
22+35	2.9066	0.66	Q			V
22+40	2.9112	0.66	Q			V
22+45	2.9157	0.65	Q			V
22+50	2.9201	0.65	Q			V
22+55	2.9245	0.64	Q			V
23+ 0	2.9289	0.64	Q			V
23+ 5	2.9333	0.63	Q			V
23+10	2.9376	0.63	Q			V
23+15	2.9419	0.62	Q			V
23+20	2.9461	0.62	Q			V
23+25	2.9503	0.61	Q			V
23+30	2.9545	0.61	Q			V
23+35	2.9587	0.60	Q			V
23+40	2.9628	0.60	Q			V
23+45	2.9669	0.60	Q			V
23+50	2.9710	0.59	Q			V
23+55	2.9751	0.59	Q			V
24+ 0	2.9791	0.58	Q			V
24+ 5	2.9830	0.56	Q			V
24+10	2.9859	0.43	Q			V
24+15	2.9877	0.25	Q			V
24+20	2.9888	0.17	Q			V
24+25	2.9897	0.12	Q			V
24+30	2.9903	0.09	Q			V
24+35	2.9908	0.07	Q			V
24+40	2.9911	0.05	Q			V
24+45	2.9914	0.04	Q			V
24+50	2.9916	0.03	Q			V
24+55	2.9917	0.02	Q			V
25+ 0	2.9918	0.01	Q			V
25+ 5	2.9919	0.01	Q			V
25+10	2.9919	0.01	Q			V
25+15	2.9920	0.01	Q			V
25+20	2.9920	0.00	Q			V

Unit Hydrograph Analysis

Copyright (c) CIVILCADD/CIVILDESIGN, 1989 - 2018, Version 9.0

Study date 07/01/23

+++++

San Bernardino County Synthetic Unit Hydrology Method
Manual date - August 1986

Program License Serial Number 6434

**100 YEAR 24 HOUR STORM
AMC III
DEVELOPED 30 ACRE DA3**

Storm Event Year = 100

Antecedent Moisture Condition = 3

English (in-lb) Input Units Used

English Rainfall Data (Inches) Input Values Used

English Units used in output format

Area averaged rainfall intensity isohyetal data:

Sub-Area (Ac.)	Duration (hours)	Isohyetal (In)
Rainfall data for year 100		
5.35	1	1.08

Rainfall data for year 100		
5.35	6	2.01

Rainfall data for year 100		
5.35	24	3.44

+++++

***** Area-averaged max loss rate, Fm *****

SCS curve No. (AMCII)	SCS curve NO. (AMC 3)	Area (Ac.)	Area Fraction	Fp(Fig C6) (In/Hr)	Ap (dec.)	Fm (In/Hr)
56.0	75.8	5.35	1.000	0.440	0.050	0.022

Area-averaged adjusted loss rate Fm (In/Hr) = 0.022

***** Area-Averaged low loss rate fraction, Yb *****

Area	Area	SCS CN	SCS CN	S	Pervious
------	------	--------	--------	---	----------

(Ac.)	Fract	(AMC2)	(AMC3)		Yield Fr
0.27	0.050	56.0	75.8	3.19	0.381
5.08	0.950	98.0	98.0	0.20	0.932

Area-averaged catchment yield fraction, Y = 0.905
 Area-averaged low loss fraction, Yb = 0.095
 User entry of time of concentration = 0.164 (hours)
 +++++
 Watershed area = 5.35(Ac.)
 Catchment Lag time = 0.131 hours
 Unit interval = 5.000 minutes
 Unit interval percentage of lag time = 63.6716
 Hydrograph baseflow = 0.00 (CFS)
 Average maximum watershed loss rate(Fm) = 0.022(In/Hr)
 Average low loss rate fraction (Yb) = 0.095 (decimal)
 DESERT S-Graph Selected
 Computed peak 5-minute rainfall = 0.512(In)
 Computed peak 30-minute rainfall = 0.877(In)
 Specified peak 1-hour rainfall = 1.080(In)
 Computed peak 3-hour rainfall = 1.581(In)
 Specified peak 6-hour rainfall = 2.010(In)
 Specified peak 24-hour rainfall = 3.440(In)

Rainfall depth area reduction factors:
 Using a total area of 5.35(Ac.) (Ref: fig. E-4)

5-minute factor = 1.000	Adjusted rainfall = 0.512(In)
30-minute factor = 1.000	Adjusted rainfall = 0.877(In)
1-hour factor = 1.000	Adjusted rainfall = 1.080(In)
3-hour factor = 1.000	Adjusted rainfall = 1.581(In)
6-hour factor = 1.000	Adjusted rainfall = 2.010(In)
24-hour factor = 1.000	Adjusted rainfall = 3.440(In)

U n i t H y d r o g r a p h

+++++

Interval Number	'S' Graph Mean values	Unit Hydrograph ((CFS))
(K = 64.70 (CFS))		
1	6.310	4.083
2	45.049	25.065
3	70.263	16.313
4	81.125	7.028
5	87.517	4.136
6	91.543	2.605
7	94.346	1.813
8	96.309	1.270
9	97.608	0.841
10	98.370	0.493
11	99.123	0.487
12	99.701	0.374
13	100.000	0.193

Total soil rain loss = 0.24(In)
 Total effective rainfall = 3.20(In)
 Peak flow rate in flood hydrograph = 16.01(CFS)

+++++

24 - H O U R S T O R M
R u n o f f H y d r o g r a p h

Hydrograph in 5 Minute intervals ((CFS))

Time(h+m)	Volume	Ac.Ft	Q(CFS)	0	5.0	10.0	15.0	20.0
0+ 5	0.0001		0.02	Q				
0+10	0.0010		0.12	Q				
0+15	0.0023		0.19	Q				
0+20	0.0038		0.22	Q				
0+25	0.0054		0.24	Q				
0+30	0.0072		0.25	Q				
0+35	0.0090		0.26	Q				
0+40	0.0108		0.27	Q				
0+45	0.0126		0.27	Q				
0+50	0.0145		0.27	Q				
0+55	0.0164		0.28	Q				
1+ 0	0.0183		0.28	Q				
1+ 5	0.0203		0.28	Q				
1+10	0.0222		0.28	Q				
1+15	0.0241		0.28	Q				
1+20	0.0261		0.28	Q				
1+25	0.0280		0.28	Q				
1+30	0.0300		0.28	Q				
1+35	0.0320		0.29	Q				
1+40	0.0339		0.29	Q				
1+45	0.0359		0.29	QV				
1+50	0.0379		0.29	QV				
1+55	0.0399		0.29	QV				
2+ 0	0.0419		0.29	QV				
2+ 5	0.0439		0.29	QV				
2+10	0.0459		0.29	QV				
2+15	0.0480		0.29	QV				
2+20	0.0500		0.30	QV				
2+25	0.0520		0.30	QV				
2+30	0.0541		0.30	QV				
2+35	0.0561		0.30	QV				
2+40	0.0582		0.30	QV				
2+45	0.0603		0.30	QV				
2+50	0.0623		0.30	QV				
2+55	0.0644		0.30	QV				
3+ 0	0.0665		0.30	QV				
3+ 5	0.0686		0.31	QV				
3+10	0.0707		0.31	QV				
3+15	0.0728		0.31	Q V				
3+20	0.0750		0.31	Q V				
3+25	0.0771		0.31	Q V				
3+30	0.0792		0.31	Q V				
3+35	0.0814		0.31	Q V				
3+40	0.0836		0.31	Q V				
3+45	0.0857		0.31	Q V				
3+50	0.0879		0.32	Q V				
3+55	0.0901		0.32	Q V				
4+ 0	0.0923		0.32	Q V				
4+ 5	0.0945		0.32	Q V				
4+10	0.0967		0.32	Q V				
4+15	0.0989		0.32	Q V				
4+20	0.1012		0.32	Q V				
4+25	0.1034		0.33	Q V				
4+30	0.1057		0.33	Q V				
4+35	0.1079		0.33	Q V				

4+40	0.1102	0.33	Q	V
4+45	0.1125	0.33	Q	V
4+50	0.1148	0.33	Q	V
4+55	0.1171	0.33	Q	V
5+ 0	0.1194	0.34	Q	V
5+ 5	0.1217	0.34	Q	V
5+10	0.1241	0.34	Q	V
5+15	0.1264	0.34	Q	V
5+20	0.1288	0.34	Q	V
5+25	0.1311	0.34	Q	V
5+30	0.1335	0.35	Q	V
5+35	0.1359	0.35	Q	V
5+40	0.1383	0.35	Q	V
5+45	0.1407	0.35	Q	V
5+50	0.1431	0.35	Q	V
5+55	0.1456	0.35	Q	V
6+ 0	0.1480	0.36	Q	V
6+ 5	0.1505	0.36	Q	V
6+10	0.1530	0.36	Q	V
6+15	0.1555	0.36	Q	V
6+20	0.1580	0.36	Q	V
6+25	0.1605	0.36	Q	V
6+30	0.1630	0.37	Q	V
6+35	0.1655	0.37	Q	V
6+40	0.1681	0.37	Q	V
6+45	0.1706	0.37	Q	V
6+50	0.1732	0.37	Q	V
6+55	0.1758	0.38	Q	V
7+ 0	0.1784	0.38	Q	V
7+ 5	0.1811	0.38	Q	V
7+10	0.1837	0.38	Q	V
7+15	0.1863	0.39	Q	V
7+20	0.1890	0.39	Q	V
7+25	0.1917	0.39	Q	V
7+30	0.1944	0.39	Q	V
7+35	0.1971	0.39	Q	V
7+40	0.1998	0.40	Q	V
7+45	0.2026	0.40	Q	V
7+50	0.2054	0.40	Q	V
7+55	0.2081	0.40	Q	V
8+ 0	0.2109	0.41	Q	V
8+ 5	0.2137	0.41	Q	V
8+10	0.2166	0.41	Q	V
8+15	0.2194	0.41	Q	V
8+20	0.2223	0.42	Q	V
8+25	0.2252	0.42	Q	V
8+30	0.2281	0.42	Q	V
8+35	0.2310	0.42	Q	V
8+40	0.2340	0.43	Q	V
8+45	0.2369	0.43	Q	V
8+50	0.2399	0.43	Q	V
8+55	0.2429	0.44	Q	V
9+ 0	0.2459	0.44	Q	V
9+ 5	0.2490	0.44	Q	V
9+10	0.2521	0.45	Q	V
9+15	0.2552	0.45	Q	V
9+20	0.2583	0.45	Q	V
9+25	0.2614	0.46	Q	V
9+30	0.2646	0.46	Q	V
9+35	0.2678	0.46	Q	V
9+40	0.2710	0.47	Q	V
9+45	0.2742	0.47	Q	V
9+50	0.2775	0.47	Q	V

9+55	0.2808	0.48	Q	V				
10+ 0	0.2841	0.48	Q	V				
10+ 5	0.2874	0.49	Q	V				
10+10	0.2908	0.49	Q	V				
10+15	0.2942	0.49	Q	V				
10+20	0.2976	0.50	Q	V				
10+25	0.3011	0.50	Q	V				
10+30	0.3046	0.51	Q	V				
10+35	0.3081	0.51	Q	V				
10+40	0.3116	0.52	Q	V				
10+45	0.3152	0.52	Q	V				
10+50	0.3188	0.53	Q	V				
10+55	0.3225	0.53	Q	V				
11+ 0	0.3262	0.54	Q	V				
11+ 5	0.3299	0.54	Q	V				
11+10	0.3337	0.55	Q	V				
11+15	0.3375	0.55	Q	V				
11+20	0.3413	0.56	Q	V				
11+25	0.3452	0.56	Q	V				
11+30	0.3491	0.57	Q	V				
11+35	0.3531	0.58	Q	V				
11+40	0.3571	0.58	Q	V				
11+45	0.3611	0.59	Q	V				
11+50	0.3652	0.60	Q	V				
11+55	0.3694	0.60	Q	V				
12+ 0	0.3736	0.61	Q	V				
12+ 5	0.3778	0.61	Q	V				
12+10	0.3819	0.59	Q	V				
12+15	0.3859	0.59	Q	V				
12+20	0.3900	0.59	Q	V				
12+25	0.3940	0.59	Q	V				
12+30	0.3981	0.60	Q	V				
12+35	0.4023	0.60	Q	V				
12+40	0.4065	0.61	Q	V				
12+45	0.4108	0.62	Q	V				
12+50	0.4151	0.63	Q	V				
12+55	0.4195	0.64	Q	V				
13+ 0	0.4239	0.65	Q	V				
13+ 5	0.4285	0.66	Q	V				
13+10	0.4331	0.67	Q	V				
13+15	0.4378	0.68	Q	V				
13+20	0.4426	0.70	Q	V				
13+25	0.4475	0.71	Q	V				
13+30	0.4524	0.72	Q	V				
13+35	0.4575	0.74	Q	V				
13+40	0.4627	0.75	Q	V				
13+45	0.4680	0.77	Q	V				
13+50	0.4734	0.79	Q	V				
13+55	0.4790	0.80	Q	V				
14+ 0	0.4846	0.82	Q	V				
14+ 5	0.4905	0.84	Q	V				
14+10	0.4964	0.87	Q	V				
14+15	0.5026	0.89	Q	V				
14+20	0.5089	0.92	Q	V				
14+25	0.5154	0.94	Q	V				
14+30	0.5221	0.97	Q	V				
14+35	0.5290	1.00	Q	V				
14+40	0.5361	1.04	Q	V				
14+45	0.5435	1.08	Q	V				
14+50	0.5513	1.12	Q	V				
14+55	0.5593	1.17	Q	V				
15+ 0	0.5677	1.23	Q	V				
15+ 5	0.5766	1.28	Q	V				

15+10	0.5860	1.36	Q		V		
15+15	0.5958	1.44	Q		V		
15+20	0.6064	1.53	Q		V		
15+25	0.6176	1.62	Q		V		
15+30	0.6289	1.65	Q		V		
15+35	0.6408	1.72	Q		V		
15+40	0.6539	1.90	Q		V		
15+45	0.6684	2.11	Q		V		
15+50	0.6854	2.46	Q		V		
15+55	0.7057	2.95	Q		V		
16+ 0	0.7333	4.01	Q	Q	V		
16+ 5	0.7823	7.11		Q	V		
16+10	0.8926	16.01				V	Q
16+15	0.9720	11.53		Q	Q	V	
16+20	1.0177	6.64				V	
16+25	1.0499	4.67		Q		V	
16+30	1.0746	3.59	Q			V	
16+35	1.0946	2.92	Q			V	
16+40	1.1112	2.40	Q			V	
16+45	1.1249	1.99	Q			V	
16+50	1.1363	1.66	Q			V	
16+55	1.1468	1.52	Q			V	
17+ 0	1.1560	1.34	Q			V	
17+ 5	1.1640	1.16	Q			V	
17+10	1.1708	0.99	Q			V	
17+15	1.1772	0.93	Q			V	
17+20	1.1832	0.87	Q			V	
17+25	1.1889	0.83	Q			V	
17+30	1.1943	0.79	Q			V	
17+35	1.1995	0.75	Q			V	
17+40	1.2045	0.72	Q			V	
17+45	1.2093	0.69	Q			V	
17+50	1.2139	0.67	Q			V	
17+55	1.2183	0.65	Q			V	
18+ 0	1.2226	0.63	Q			V	
18+ 5	1.2269	0.61	Q			V	
18+10	1.2311	0.62	Q			V	
18+15	1.2354	0.62	Q			V	
18+20	1.2396	0.61	Q			V	
18+25	1.2437	0.60	Q			V	
18+30	1.2477	0.59	Q			V	
18+35	1.2517	0.58	Q			V	
18+40	1.2556	0.57	Q			V	
18+45	1.2594	0.55	Q			V	
18+50	1.2632	0.54	Q			V	
18+55	1.2668	0.53	Q			V	
19+ 0	1.2704	0.52	Q			V	
19+ 5	1.2740	0.51	Q			V	
19+10	1.2775	0.51	Q			V	
19+15	1.2809	0.50	Q			V	
19+20	1.2842	0.49	Q			V	
19+25	1.2875	0.48	Q			V	
19+30	1.2908	0.47	Q			V	
19+35	1.2940	0.47	Q			V	
19+40	1.2972	0.46	Q			V	
19+45	1.3003	0.45	Q			V	
19+50	1.3033	0.44	Q			V	
19+55	1.3063	0.44	Q			V	
20+ 0	1.3093	0.43	Q			V	
20+ 5	1.3123	0.43	Q			V	
20+10	1.3152	0.42	Q			V	
20+15	1.3180	0.42	Q			V	
20+20	1.3208	0.41	Q			V	

20+25	1.3236	0.41	Q			V
20+30	1.3264	0.40	Q			V
20+35	1.3291	0.40	Q			V
20+40	1.3318	0.39	Q			V
20+45	1.3345	0.39	Q			V
20+50	1.3371	0.38	Q			V
20+55	1.3397	0.38	Q			V
21+ 0	1.3423	0.37	Q			V
21+ 5	1.3448	0.37	Q			V
21+10	1.3473	0.37	Q			V
21+15	1.3498	0.36	Q			V
21+20	1.3523	0.36	Q			V
21+25	1.3548	0.35	Q			V
21+30	1.3572	0.35	Q			V
21+35	1.3596	0.35	Q			V
21+40	1.3619	0.34	Q			V
21+45	1.3643	0.34	Q			V
21+50	1.3666	0.34	Q			V
21+55	1.3689	0.34	Q			V
22+ 0	1.3712	0.33	Q			V
22+ 5	1.3735	0.33	Q			V
22+10	1.3757	0.33	Q			V
22+15	1.3780	0.32	Q			V
22+20	1.3802	0.32	Q			V
22+25	1.3824	0.32	Q			V
22+30	1.3846	0.32	Q			V
22+35	1.3867	0.31	Q			V
22+40	1.3888	0.31	Q			V
22+45	1.3910	0.31	Q			V
22+50	1.3931	0.31	Q			V
22+55	1.3952	0.30	Q			V
23+ 0	1.3972	0.30	Q			V
23+ 5	1.3993	0.30	Q			V
23+10	1.4013	0.30	Q			V
23+15	1.4034	0.29	Q			V
23+20	1.4054	0.29	Q			V
23+25	1.4074	0.29	Q			V
23+30	1.4094	0.29	Q			V
23+35	1.4113	0.29	Q			V
23+40	1.4133	0.28	Q			V
23+45	1.4152	0.28	Q			V
23+50	1.4172	0.28	Q			V
23+55	1.4191	0.28	Q			V
24+ 0	1.4210	0.28	Q			V
24+ 5	1.4228	0.26	Q			V
24+10	1.4238	0.15	Q			V
24+15	1.4244	0.08	Q			V
24+20	1.4247	0.05	Q			V
24+25	1.4250	0.03	Q			V
24+30	1.4251	0.02	Q			V
24+35	1.4252	0.02	Q			V
24+40	1.4253	0.01	Q			V
24+45	1.4254	0.01	Q			V
24+50	1.4254	0.00	Q			V
24+55	1.4254	0.00	Q			V
25+ 0	1.4254	0.00	Q			V

APPENDIX C
Exhibits:

Town of Apple Valley Preliminary WQMP & Checklist

PWQMP Checklist

Project Name: _____

Prepared For:

Owner/Developer Name _____

Address _____

Street, City, State, ZIP _____

Phone Number _____

Prepared By:

Engineer Name _____

RCE # _____

Engineering Firm Name _____

Address _____

City, State, ZIP _____

Phone Number _____

Project Description: _____

Regulated Development Project Category: _____

<input type="checkbox"/> #1 New Development involving the creation of 5,000 ft ² or more of impervious surface collectively over entire site.	<input type="checkbox"/> #2 Significant redevelopment involving the addition or replacement of 5,000 ft ² or more of impervious surface on an already developed site.	<input type="checkbox"/> #3 Road Project – any road, sidewalk, or bicycle lane project that creates greater than 5,000 ft ² of contiguous impervious surface.	<input type="checkbox"/> #4 LUPs – linear underground/overhead projects that has a discrete location with 5,000 ft ² or more of new constructed impervious surface.
--	--	--	--

Project Area (ft²): 1,192,814

Project Type: Industrial

Project Location: Southwest corner of Central Road and Cordova Road

Site Design Practices:

Site Design Practices Checklist
Site Design Practices <i>If yes, explain how preventative site design practice is addressed in project site plan. If no, other LID BMPs must be selected to meet targets</i>
Minimize impervious areas: Yes <input type="checkbox"/> No <input type="checkbox"/> Explanation:
Maximize natural infiltration capacity; Including improvement and maintenance of soil: Yes <input type="checkbox"/> No <input type="checkbox"/> Explanation:
Preserve existing drainage patterns and time of concentration: Yes <input type="checkbox"/> No <input type="checkbox"/> Explanation:
Disconnect impervious areas. Including rerouting of rooftop drainage pipes to drain stormwater to storage or infiltration BMPs instead of to storm drain: Yes <input type="checkbox"/> No <input type="checkbox"/> Explanation:
Use of Porous Pavement: Yes <input type="checkbox"/> No <input type="checkbox"/> Explanation:
Protect existing vegetation and sensitive areas: Yes <input type="checkbox"/> No <input type="checkbox"/> Explanation:
Re-vegetate disturbed areas. Including planting and preservation of drought tolerant vegetation: Yes <input type="checkbox"/> No <input type="checkbox"/> Explanation:
Minimize unnecessary compaction in stormwater retention/infiltration basin/trench areas: Yes <input type="checkbox"/> No <input type="checkbox"/> Explanation:
Utilize naturalized/rock-lined drainage swales in place of underground piping or imperviously lined swales: Yes <input type="checkbox"/> No <input type="checkbox"/> Explanation:
Stake off areas that will be used for landscaping to minimize compaction during construction: Yes <input type="checkbox"/> No <input type="checkbox"/> Explanation:
Use of Rain Barrels and Cisterns, Including the use of on-site water collection systems: Yes <input type="checkbox"/> No <input type="checkbox"/> Explanation:
Stream Setbacks. Includes a specified distance from an adjacent stream: Yes <input type="checkbox"/> No <input type="checkbox"/> Explanation:

LID Design Capture Volume:

LID BMP Performance Criteria for Design Capture Volume		
1 Project area DA 1 (ft ²):	2 Imperviousness after applying preventative site design practices (Imp%): 85%	3 Runoff Coefficient (Rc): 0.66127 $R_c = 0.858(\text{Imp}\%)^3 - 0.78(\text{Imp}\%)^2 + 0.774(\text{Imp}\%) + 0.04$
4 Determine 1-hour rainfall depth for a 2-year return period $P_{2\text{yr-1hr}}$ (in): 0.349 http://hdsc.nws.noaa.gov/hdsc/pfds/sa/sca_pfds.html		
5 Compute P_6 , Mean 6-hr Precipitation (inches): 0.43175 $P_6 = \text{Item 4} * C_1$, where C_1 is a function of site climatic region specified in Form 3-1 Item 1 (Desert = 1.2371)		
6 Drawdown Rate <i>Use 48 hours as the default condition. Selection and use of the 24 hour drawdown time condition is subject to approval by the local jurisdiction. The necessary BMP footprint is a function of drawdown time. While shorter drawdown times reduce the performance criteria for LID BMP design capture volume, the depth of water that can be stored is also reduced.</i>		24-hrs <input type="checkbox"/> 48-hrs <input type="checkbox"/>
7 Compute design capture volume, DCV (ft ³): 55,721 (1.28 acre feet) $DCV = 1/12 * [\text{Item 1} * \text{Item 3} * \text{Item 5} * C_2]$, where C_2 is a function of drawdown rate (24-hr = 1.582; 48-hr = 1.963) Compute separate DCV for each outlet from the project site per schematic drawn in Form 3-1 Item 2		

Infiltration BMP Feasibility:

Infiltration BMP Feasibility	
Feasibility Criterion – Complete evaluation for each DA on the Project Site	
<p>¹ Would infiltration BMP pose significant risk for groundwater related concerns? <i>Refer to Section 5.3.2.1 of the TGD for WQMP</i></p>	Yes <input type="checkbox"/> No <input type="checkbox"/>
If Yes, Provide basis: (attach)	
<p>² Would installation of infiltration BMP significantly increase the risk of geotechnical hazards? (Yes, if the answer to any of the following questions is yes, as established by a geotechnical expert):</p> <ul style="list-style-type: none"> • The location is less than 50 feet away from slopes steeper than 15 percent • The location is less than ten feet from building foundations or an alternative setback. • A study certified by a geotechnical professional or an available watershed study determines that stormwater infiltration would result in significantly increased risks of geotechnical hazards. 	Yes <input type="checkbox"/> No <input type="checkbox"/>
If Yes, Provide basis: (attach)	
<p>³ Would infiltration of runoff on a Project site violate downstream water rights?</p>	Yes <input type="checkbox"/> No <input type="checkbox"/>
If Yes, Provide basis: (attach)	
<p>⁴ Is proposed infiltration facility located on hydrologic soil group (HSG) D soils or does the site geotechnical investigation indicate presence of soil characteristics, which support categorization as D soils?</p>	Yes <input type="checkbox"/> No <input type="checkbox"/>
If Yes, Provide basis: (attach)	
<p>⁵ Is the design infiltration rate, after accounting for safety factor of 2.0, below proposed facility less than 0.3 in/hr (accounting for soil amendments)?</p>	Yes <input type="checkbox"/> No <input type="checkbox"/>
If Yes, Provide basis: (attach)	
<p>⁶ Would on-site infiltration or reduction of runoff over pre-developed conditions be partially or fully inconsistent with watershed management strategies as defined in the WAP, or impair beneficial uses? <i>See Section 3.5 of the TGD for WQMP and WAP</i></p>	Yes <input type="checkbox"/> No <input type="checkbox"/>
If Yes, Provide basis: (attach)	
<p>⁷ Any answer from Item 1 through Item 3 is “Yes”: <i>If yes, infiltration of any volume is not feasible onsite. Proceed to Form 4.3-4, Selection and Evaluation of Biotreatment BMP. If no, then proceed to Item 8 below.</i></p>	Yes <input type="checkbox"/> No <input type="checkbox"/>
<p>⁸ Any answer from Item 4 through Item 6 is “Yes”: <i>If yes, infiltration is permissible but is not required to be considered. Proceed to Form 4.3-2, Site Design BMP. If no, then proceed to Item 9, below.</i></p>	Yes <input type="checkbox"/> No <input type="checkbox"/>
<p>⁹ All answers to Item 1 through Item 6 are “No”: <i>Infiltration of the full DCV is potentially feasible, LID infiltration BMP must be designed to infiltrate the full DCV to the MEP. Proceed to Form 4.3-2, Site Design BMPs.</i></p>	

Infiltration BMPs:

Selection of Infiltration BMPs	
Pre-treatment BMPs (required for infiltration)	Infiltration BMPs
<input type="checkbox"/> Catch Basin Filter Inserts <input type="checkbox"/> Vegetated Swale <input type="checkbox"/> Hydrodynamic Separator <input type="checkbox"/> Filter Strip <input type="checkbox"/> Sedimentation Forebay <input type="checkbox"/> Other	<input type="checkbox"/> Infiltration Basin <input type="checkbox"/> Infiltration Trench <input type="checkbox"/> Bioretention with no underdrain <input type="checkbox"/> Drywell ¹ <input type="checkbox"/> Underground Infiltration System ¹

Note¹: Class V Injection Wells (including underground infiltration systems) must be registered with the U.S. EPA Region 9's Underground Injection Control (UIC) Program.

Biotreatment BMPs:

Selection of Biotreatment BMPs		
2 Biotreatment BMP Selected <i>(Select biotreatment BMP(s) necessary to ensure all pollutants of concern are addressed through Unit Operations and Processes, described in Table 5-5 of the TGD for WQMP)</i>	Volume-based biotreatment	Flow-based biotreatment
		<input type="checkbox"/> Bioretention with underdrain <input type="checkbox"/> Planter box with underdrain <input type="checkbox"/> Constructed wetlands <input type="checkbox"/> Wet extended detention <input type="checkbox"/> Dry extended detention

